



DSNI Accessible Outdoor Places Guide

2021 Edition

Issue Tracker

001 - Initial publication September 2021

Acknowledgements

Disability Sport NI would like to acknowledge and thank the following organisations and individuals for their contribution to the development of this guide:

- The Public Health Agency who generously funded the development and publication of this guide.
- The Access and Inclusion Project at Derry City & Strabane District Council who supported the project.
- All In Access Consultancy, who was commissioned to produce this guide in partnership with the Disability Sport NI team.
- Cloud Nine Project Design and Management who was commissioned to produce the technical diagrams.

Disclaimer

The views expressed in this guide are not intended to take away or diminish the responsibility of the user to comply with current or future legislation. The guidance and recommended standards provided in the guide are intended to complement requirements for Building Regulations, Town Planning Requirements or Licensing, not to replace or override them.

Whilst every effort has been made to ensure the accuracy of these guidelines, Disability Sport NI shall not be held responsible or liable to any party in respect of any loss, damage or costs of any nature arising directly or indirectly from reliance placed on this information.

Front Cover Image Credit

A Quadrix Session at All Out Trekking, Gosford Forest Park
(Image courtesy of Disability Sport NI)

Thank you to the many organisations who have contributed to this guide. Acknowledgements are listed in Appendix B.

**This document is available in
alternative formats on request**

Contents

List of Figures	5
List of Tables	5
Overview	6
Introduction	7
Principles of Inclusive Design	7
About Disability Sport NI	8
Disability Sport NI Design and Management Guidelines	8
1 Accessible Parking and External Routes	10
1.1 Parking and Setting-down	11
1.2 Accessible External Routes - Paths, Trails and Greenways	18
1.3 Barriers and Obstacles on External Routes	41
1.4 Sloped Gradients and Ramps on External Routes	52
1.5 Steps on External Routes	56
1.6 Handrails	60
1.7 Accessible External Routes - Paths, Trails and Greenways: Guidance Chart	62
1.8 Inclusive All-terrain Vehicle Trails	67
2 Multi-sensory Greenspace and Outdoor Places Amenities	72
2.1 Multi-sensory Greenspace	73
2.2 Resting Places and Seating	77
2.3 Shelters and Picnic Tables	82
2.4 Accessible Bird Hides, Viewing Areas and Platforms	85
2.5 Accessible Toilets, Changing and Showering	90
2.6 Lighting in the External Environment	103
2.7 Assistance Dogs Toileting Facilities	104
2.8 RADAR Locks	106
3 Wayfinding, Signs and Information	108
3.1 Pre-visit Information and Maps	109
3.2 Signs	111
3.3 Information Display Boards and Stands	113
3.4 Accessible Information Design and the Use of Contrast	117
3.5 Waymarkers	119
3.6 Tactile Maps, Models and Interpretation panels	121
3.7 Audio Description and Audio Information	122
3.8 Designing for Colour Blindness	123
3.9 Use of Orientation Cues in Outdoor Places	124
3.10 Using Route Phototrails	125
3.11 Signs on Blueways	127

4	Access to Water	128
4.1	Access to Water-based Activities	129
4.2	Jetties and Pontoons	130
4.3	Slipways and Gangways	139
4.4	Hoist Provision and Equipment	140
4.5	Accessible Angling Facilities	152
4.6	Access to Beaches	163
5	Outdoor Wheelchairs, Adapted Cycles and Inclusive All-terrain Vehicles	171
5.1	Outdoor Wheelchairs	172
5.2	Adapted Cycles	176
5.3	Inclusive All-terrain Vehicles	179
6	Inclusive Play - Accessible Play Parks and Play Equipment	185
6.1	Accessible Play Parks	187
6.2	Accessible Play Equipment	188
6.3	Play Park Surfaces	198
6.4	Slopes and Planting in Play Parks	200
6.5	Associated Play Park Facilities	201
	Appendices	203
	Appendix A The Importance of Maintenance	204
	Appendix B Acknowledgements	205

List of Figures

Figure 1	Accessible Parking Bays	13
Figure 2	Typical Layouts of Setting-down and Pick-up Point	15
Figure 3	Parking for Adapted Cycles, Mobility Scooters and All-terrain Vehicles	17
Figure 4	Accessible External Route Widths	22
Figure 5	Clear Headroom	23
Figure 6	Crossfall and Camber	33
Figure 7	Typical Boardwalk and Bridge	37
Figure 8	Space at Gates	45
Figure 9	Staggered Barriers	49
Figure 10	External Slopes and Ramps	54
Figure 11	External Steps	57
Figure 12	Planting Bank	75
Figure 13	Raised Beds (sand, water and planting)	75
Figure 14	Features of an Accessible External Route	80
Figure 15	Accessible Picnic Tables	84
Figure 16	Accessible Bird Hides	86
Figure 17	Observation Platforms and Viewing Telescopes	89
Figure 18	Ambulant WC Cubicle; Urinals and Wash Hand Basins (accessible to wheelchair users and ambulant disabled people)	92
Figure 19	Unisex Wheelchair Accessible WC	94
Figure 20	Changing Places Toilet	97
Figure 21	Inclusive Changing Area (with wheelchair accessible incorporated provisions)	100
Figure 22	Self-contained Unisex Accessible Changing/Shower/WC Unit	102
Figure 23	Assistance Dogs Toileting Facility	105
Figure 24	Interpretation Panels	115
Figure 25	Information Shelter	115
Figure 26	Floating Pontoon	130
Figure 27	Design Options for Accessible Fishing Stands and Platforms	156 - 158

List of Tables

Table 1	Accessible External Routes - Paths, Trails and Greenways: Guidance Chart	66
Table 2	Location of Signs Relating to Viewing Distance	112
Table 3	Sign Font Heights and Colour Contrast Examples	113
Table 4	The Use of Orientation Cues	124

Overview

Overview

Introduction

These design guidelines have been developed in response to a growing demand from disabled people in Northern Ireland to access and use outdoor places for exercise and recreation.

They address the fact that many outdoor places, in both urban and countryside areas, are currently not fully inclusive of disabled people. This is because of a range of barriers including the poor design of external routes, inaccessible gates and stiles, and the lack of provision of accessible parking, accessible toilets and other amenities.

These guidelines aim to promote a greater understanding of inclusive design and provide detailed technical advice and information which will encourage and support designers and site managers to embrace optimum levels of good practice in terms of access for disabled people.

Principles of Inclusive Design

Inclusive design is the “approach to the design of the environment, including buildings and their surrounding spaces, and managed and natural landscapes, to ensure that they can be accessed and used by everyone.”¹

The Commission for Architecture and the Built Environment regards the five key inclusive design principles to be:

- Inclusive design places people at the heart of the design process.
- Inclusive design acknowledges diversity and difference.
- Inclusive design offers choice where a single design solution cannot accommodate all users.
- Inclusive design provides for flexibility in use i.e. adaptable to changing use and demand.
- Inclusive design provides buildings and environments that are convenient and enjoyable to use for everyone.²

¹ British Standards Institute. BS 8300-1:2018. Design of an accessible and inclusive built environment. Part 1: External environment. Code of practice. 2018.

² The Principles of Inclusive Design. (They include you.) Commission for Architecture and the Built Environment. 2006.

About Disability Sport NI

Disability Sport NI is Northern Ireland's main disability sports charity working to improve the health and wellbeing of disabled people through sport and active recreation.

We believe that every person with a disability has the right to participate in all aspects of life and are committed to building a more inclusive society where disabled people have the same opportunity as non-disabled people to lead a full, active and healthy lifestyle through sport and active recreation.

Disability Sport NI Design and Management Guidelines

This guide is one of a series of five design and management guides produced by Disability Sport NI to encourage and support the development and management of sports facilities, stadia and outdoor places which are fully inclusive of disabled people:

- Guide 1: Accessible Sports Facilities Design Guidelines
- Guide 2: Accessible Sports Facilities Management Guidelines
- Guide 3: Accessible Sports Stadia Design Guidelines
- Guide 4: Accessible Sports Stadia Management Guidelines
- Guide 5: Accessible Outdoor Places Design Guidelines

In addition two 'Guidance Notes' have also been produced for Sports Pavilions and Boxing Facilities. All guides and guidance notes are available from the Disability Sport NI website: www.dsni.co.uk



Guidance Signpost

- ▶ There are a range of existing resources available when considering the design of accessible outdoor places. Guidance Signposts have been provided in this publication where relevant to promote further research and assistance, particularly where this relates to expertise in a particular field or area of inclusive design.



Section

1

Accessible Parking and External Routes

- 1.1 Parking and Setting-down
- 1.2 Accessible External Routes - Paths, Trails and Greenways
- 1.3 Barriers and Obstacles on External Routes
- 1.4 Sloped Gradients and External Ramps on External Routes
- 1.5 Steps on External Routes
- 1.6 Handrails
- 1.7 Accessible External Routes - Paths, Trails and Greenways: Guidance Chart
- 1.8 Inclusive All-Terrain Vehicle Trails

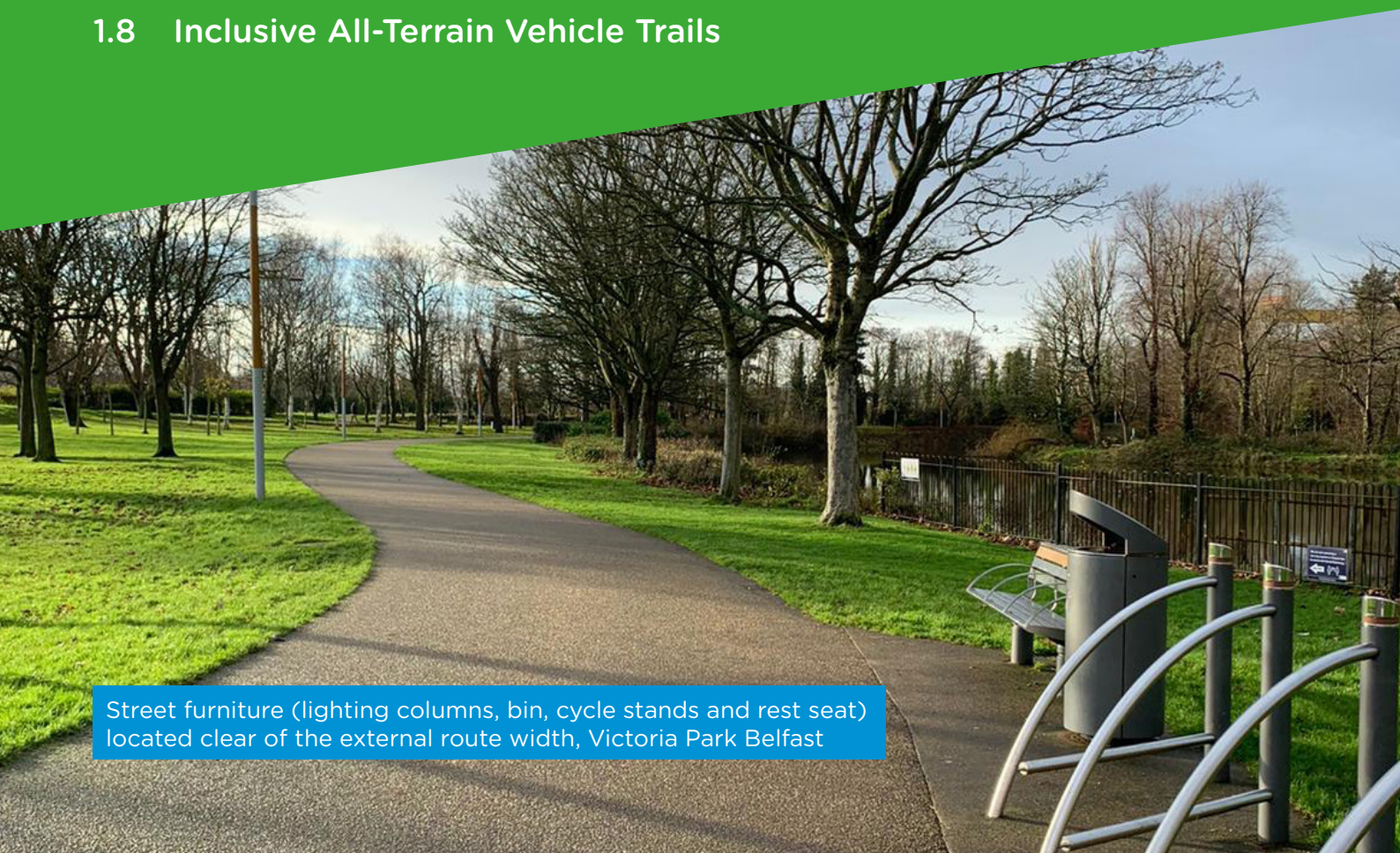
A photograph of a paved path in a park. The path is made of dark gravel and curves through a grassy area with many trees. In the foreground, there is a metal bench and a trash bin. A blue text box is overlaid on the bottom left of the image.

Street furniture (lighting columns, bin, cycle stands and rest seat) located clear of the external route width, Victoria Park Belfast

1.1 Parking and Setting-down

Overview

The provision of designated accessible parking and setting-down points is critical to ensuring that disabled people can access outdoor places and associated outdoor recreation opportunities.

1.1.1 Designated on-site accessible parking provision

Recommended Standards

- The recommended number of accessible car parking bays for outdoor places should be a minimum of two accessible parking bays or 8% of total parking capacity, whichever is the greatest.
- Where outdoor places have a particular focus on activities for disabled people and/or are used for outdoor events, this capacity requirement may increase significantly. This increased need should be addressed by the site managers.
- Locate accessible car parking provisions as close as possible to the start of an external route which leads to associated on-site facilities and entrances e.g. in close proximity to the nearest on-bank accessible fishing stand, or entrance to a play park. Where feasible this should be within 50m (maximum 100m).
- Include an additional 4% of total parking capacity for larger designated parking bays, to cater for vehicles converted for side or rear access using hoists or ramps.



Guidance Signpost

- ▶ BS 8300-1:2018. **Paragraph 7.9** Electric vehicle charging, p.23.
- ▶ BS 8300-1:2018. **Paragraph 7.4** General provision, p.17-18.



Informal accessible parking area signage



Formal accessible parking area



Blue Badge Holders Only Signage

1.1.2 Design of accessible parking bays

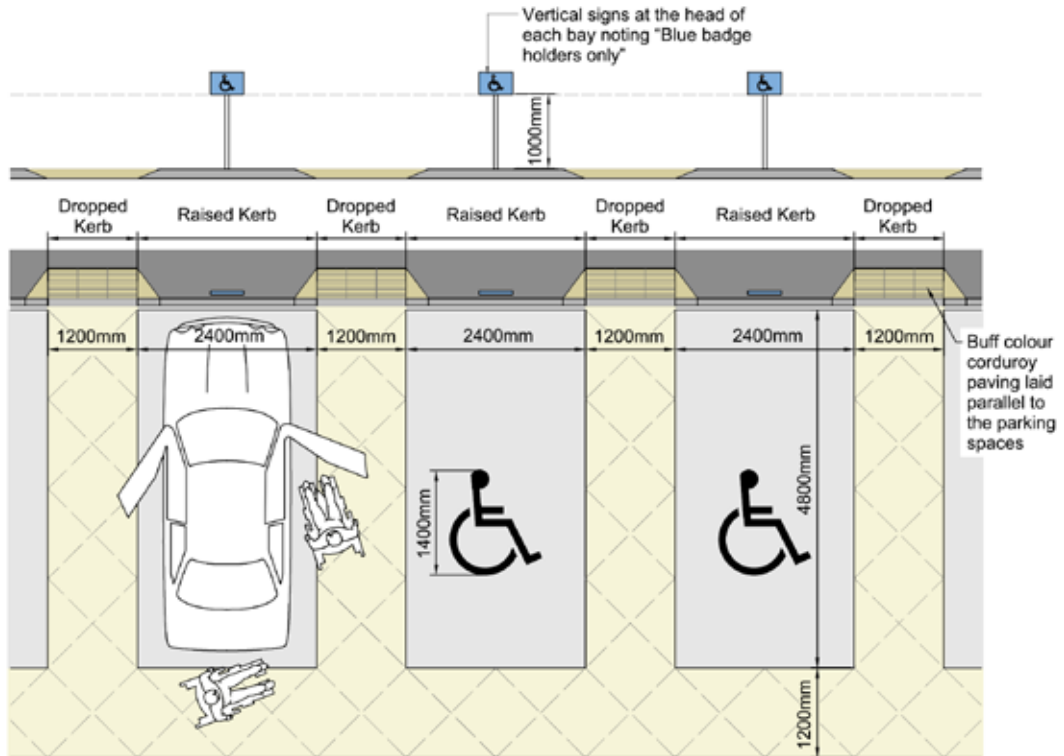

Diagram A

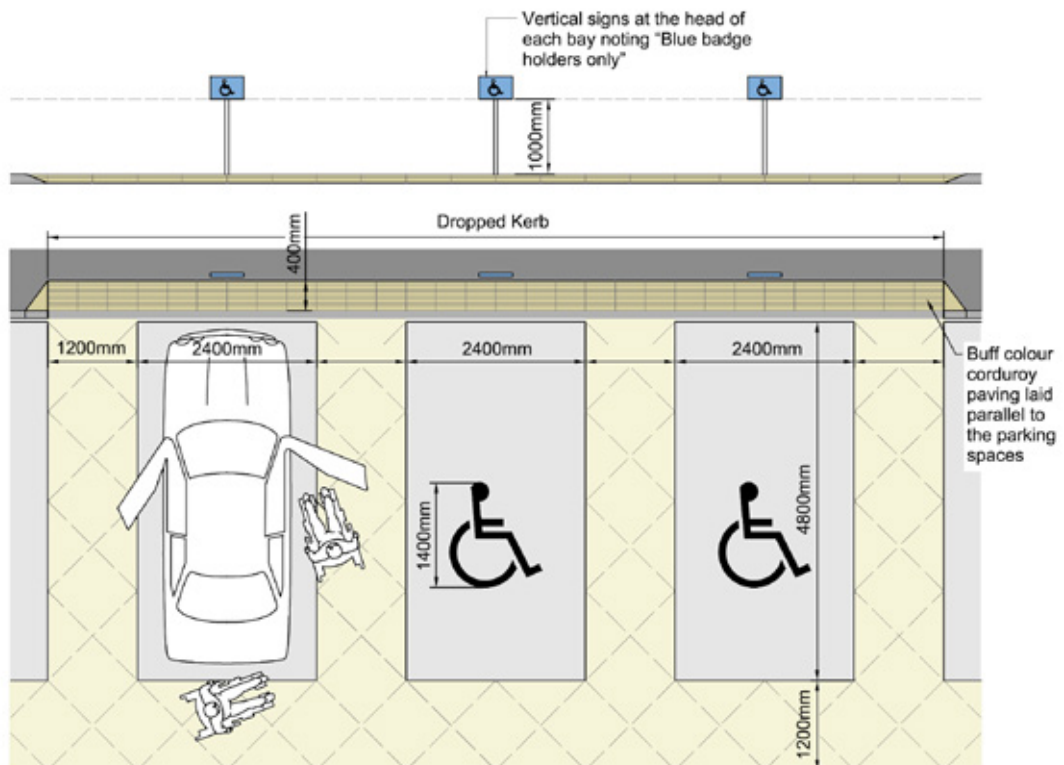

Diagram B

Figure 1 - Accessible Parking Bays

Recommended Standards

- Designated accessible car parking bays should be marked out in accordance with Figure 1: Accessible Parking Bays; preferably comprising a raised and dropped kerb arrangement (Diagram A). Where a dropped kerbline is installed along the entire length of an accessible parking zone it should include buff corduroy hazard warning paving along its entire length (Diagram B).
- Signs are required to denote accessible parking areas and bays. These signs should contrast visually with the background against which they are seen. **Note:** this will assist in identifying accessible parking bays easily, including in dark conditions.
- Accessible parking should be located on firm, level ground surfaces e.g. using existing hardstand surfaces. On greenfield sites, locate parking where external routes to and from bays will remain usable should ground conditions become muddy and wet. If necessary, use a suitable ground reinforcement subsurface. See Section 1.2.5 of this guide: External route ground surfaces.
- An accessible path of a high standard should be provided from accessible parking bays to the associated outdoor facilities. The design of external routes between accessible parking and associated outdoor facilities should comply with the Recommended Standards specified in Section 1.2 of this guide: Accessible External Routes - Paths, Trails and Greenways.
- Parking areas should be well lit where evening and night-time opening to the public is intended.
- Larger designated parking bays to cater for vehicles converted for side or rear access using hoists or ramps should be 4800mm wide by 8000mm long.
- Parking areas should be managed to ensure accessible provisions are available for disabled people when needed. Introduce a policy to give priority use on site and for the monitoring and enforcement of misuse.

1.1.3 Setting-down and pick-up point

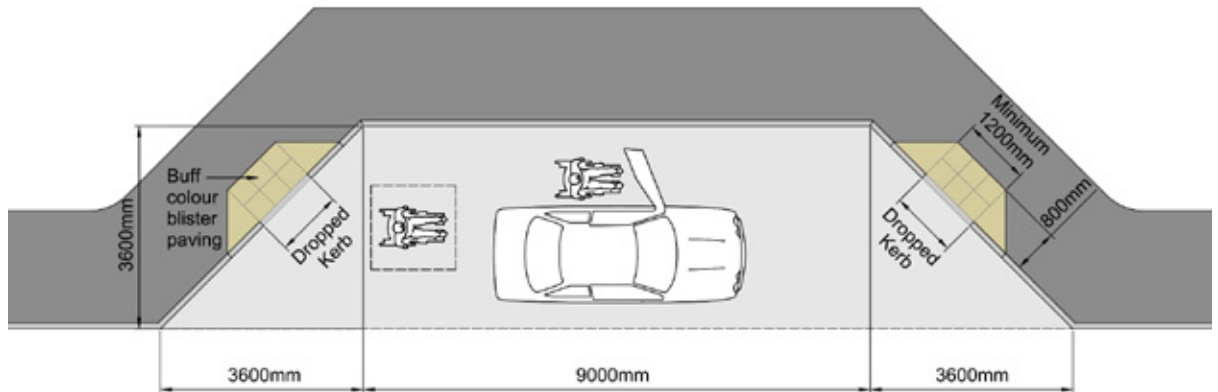

Diagram A

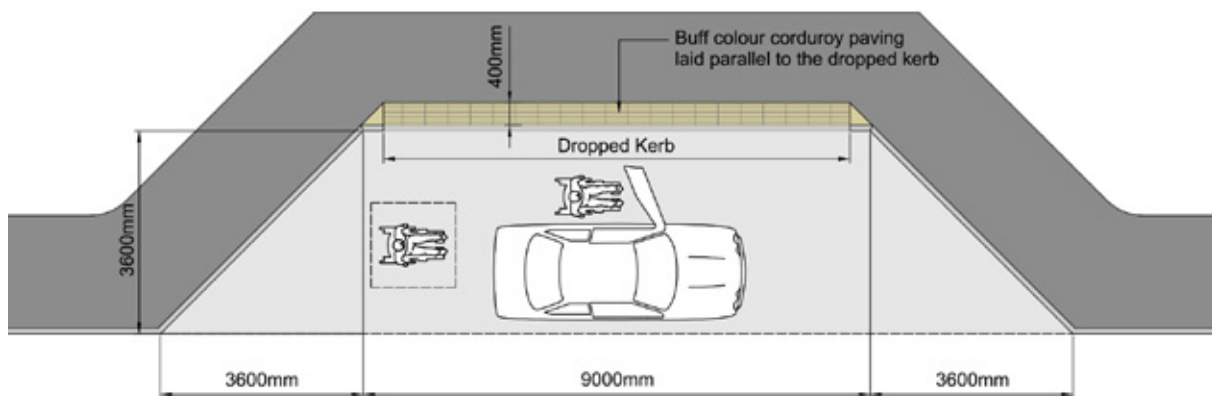

Diagram B

Figure 2 - Typical Layouts of Setting-down and Pick-up Point

Recommended Standards

- The provision of a setting-down/pick-up point suitable for use by cars, taxis and accessible buses is essential. This should be located as close as possible to the start of an external route which leads to associated on-site facilities and entrances e.g. in close proximity to the nearest on-bank accessible fishing stand, or entrance to a play park. If possible this should be within 50m (maximum 100m) and preferably in a covered area.
- Location permitting, the setting-down and pick-up point should be:
 - In accordance with Figure 2 of this guide: Typical Layouts of Setting-down and Pick-up Point; preferably using a dropped kerb along the entire 9000mm length of the bay, which should include buff corduroy hazard warning paving along its entire length (Diagram B). **Note:** alternatively, where a kerb is considered necessary for security purposes or to prevent encroachment onto an external route, dropped kerbs should be installed at both ends and include buff blister hazard warning paving (Diagram A).

- Clearly identified using a vertical sign and clearly marked at ground level where ground surfaces permit.



Guidance Signpost

- ▶ BS 8300-1:2018. **Paragraph 6.1** Setting-down and picking-up points, p.11-12.

1.1.4 Parking for mobility scooters, cycles, adapted cycles and all-terrain vehicles

Overview

Mobility scooters, cycles and adapted cycles are increasingly being used by disabled people and older people as a viable method of accessing outdoor places. Inclusive all-terrain vehicles are also in use in a small number of outdoor places to give disabled people the opportunity to explore mountain bike trails and walking trails (See Section 1.8 of this guide: Inclusive All-Terrain Vehicle Trails).

Where mobility scooters, cycles, adapted cycles and all-terrain vehicles are expected to be used, the following standards should be applied.

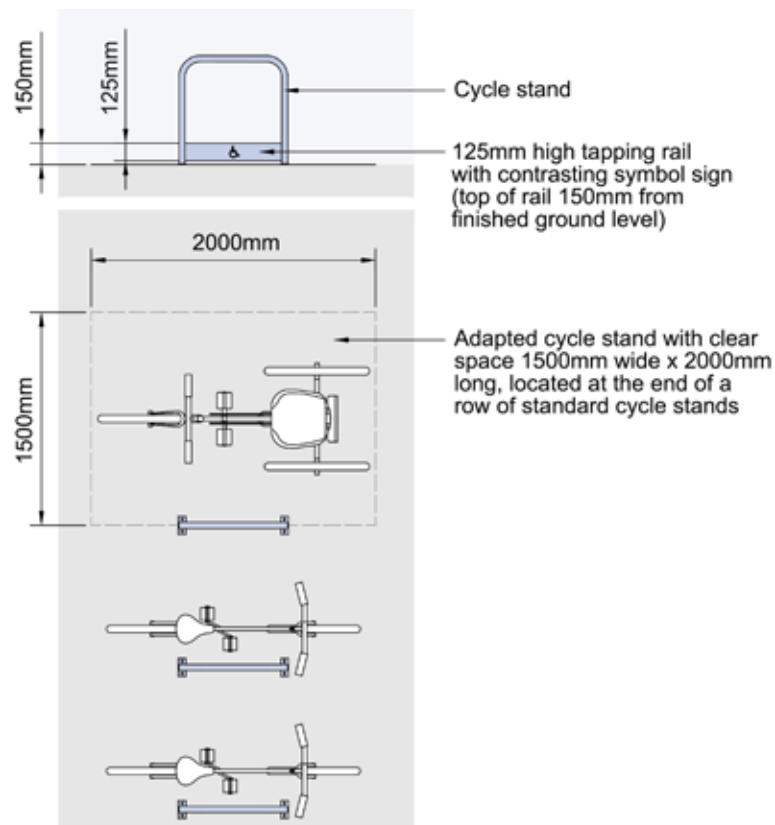

Diagram A - Adapted Cycle Stand

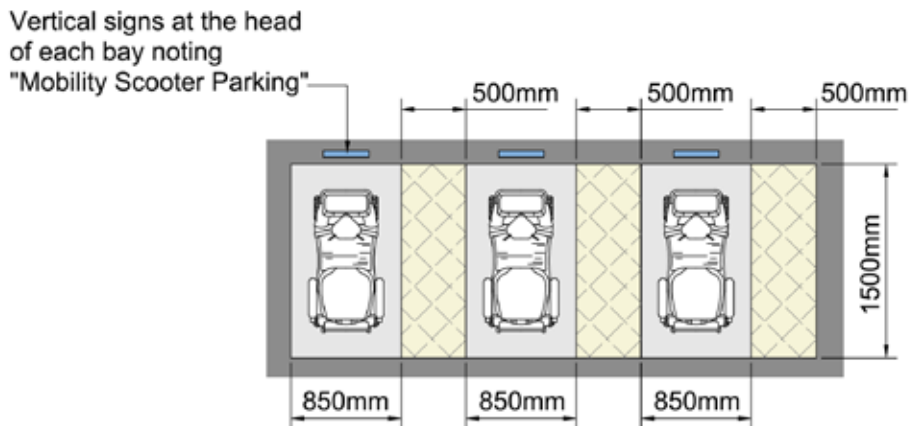

Diagram B - Mobility Scooter Parking

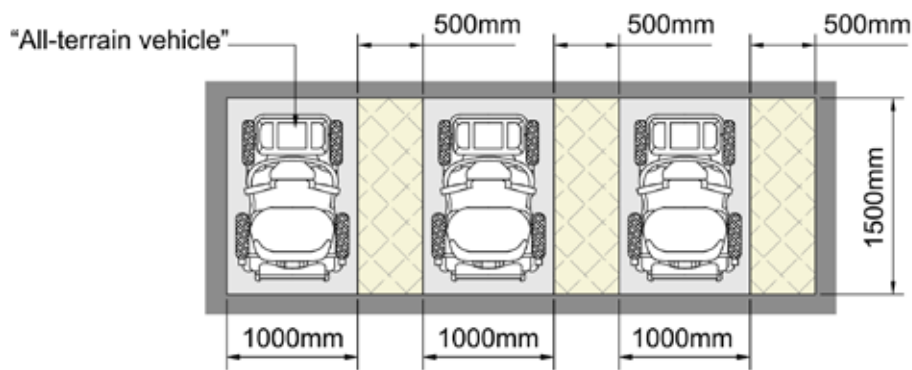

Diagram C - All-terrain Vehicle Parking

Figure 3 - Parking for Adapted Cycles, Mobility Scooters and All-terrain Vehicles

Recommended Standards

- Designated parking facilities should be marked out in accordance with Figure 3 - Parking for Adapted Cycles, Mobility Scooters and All-terrain Vehicles.
- Where feasible parking facilities should be covered by a form of weather protection and include charging points.



Guidance Signpost

- ▶ BS 8300-1:2018 **Paragraph 7.1** Cycle parking, p.16.
- ▶ BS 8300-1:2018. **Paragraph 7.10** Mobility services and provision for electric mobility scooters, p.23.
- ▶ BS 8300-2:2018. **Annex G** (informative) Table G.5 Space required for a sample of electric scooters when stationary, p.195; Table G.10 Space required for users of electric scooters to turn through 90°, p.197; Table G.15 Space required for a user to turn an electric scooter through 180°, p.199.

1.2 Accessible External Routes - Paths, Trails and Greenways

Definition

For the purposes of this guide, an accessible external route is a single-use or shared-use path, trail or greenway (traffic-free), which can be used for activities such as walking and wheeling, cycling, horse riding and trekking.

Overview

Different types of external routes will comprise different features e.g. linear corridors such as riverside paths and greenways, forest sensory trails, open space and urban park path networks etc. External routes may be natural within an existing terrain, or manmade – the latter often being associated with easier access in terms of surface and gradient, such as formal path and greenway networks. The optimum is a level, slip resistant, well-drained route with no barriers and where potential trip hazards such as tree roots and protruding stones are avoided. There is an expectation that good accessibility is more easily achieved within manmade urban or managed environments and parks, than in the countryside setting.

In some circumstances, it might not be considered reasonable to change an external route in its entirety to meet highest design standards. For example, due to excessive cost, unsuitable terrain, detriment to the local ecosystem/landscape or for safety reasons. However, site managers are encouraged to demonstrate that every option to provide “**least restrictive access**”³ has been explored and that environmental quality has not been viewed as a factor that limits potential for improvement where it can be sensitively achieved.

1.2.1 Planning external route networks

Recommended Standards

- Design routes in accordance with Sections 1.2 - 1.6 of this guide.
- Offer routes that are instinctive and easy to follow e.g. looped/circular paths.
- Avoid the use of meandering routes and unnecessary changes in direction which may cause fatigue, confusion and disorientation e.g. to ambulant disabled people and people with Dementia.
- Utilise and incorporate features of interest and views along routes to enhance multi-sensory experience.
- Incorporate signed escape and easy return points back to the entry/start point on longer linear routes.

³ Defined as “a principle applied to all work to ensure it aspires to the highest standards possible.” By All Reasonable Means: Least restrictive access to the outdoors. A guide produced by the Sensory Trust in collaboration with, and on behalf of, Natural Resources Wales. Natural Resources Wales. December 2017.

1.2.2 Single-use and shared-use external routes



Cycle/walking lane and trotting strip with softer surface finish adjacent on shared-use external route (Image courtesy of Sustrans)

Overview

Accessible traffic-free external routes have benefits for people with a wide range of abilities and needs.

1.2.2.1 Benefits of single-use routes

- Pedestrians may feel safer on single-use walking routes where cycles and horses are not present and less width is required.
- Cyclists can maintain speed on single-use routes without conflicting with other users.
- Single-use horse riding trails can utilise ground surfaces specific for this activity, which may prove difficult for other users (alternatively, incorporating an adjacent softer surface trotting strip could be considered on shared-use routes).
- There is likely to be less conflict at features of interest along a single-use route, whereas high volumes of differing traffic type can be unnerving for some disabled people.

1.2.2.2 Benefits of shared-use routes

- On shared-use routes, groups and different generations of the same family can enjoy and benefit from participating in a range of activity together.
- Shared-use routes can be designed successfully and inclusively to minimise conflict if all user needs are carefully considered and accounted for from the outset, including the integration of specific design features to ensure safe use e.g. clear delineation and low gradient.
- For safety, it is possible to segregate pedestrian and cycle lanes on shared-use routes e.g. using a change in level comprising contrasting bevelled-edge kerbs minimum 60mm high.
- Where integration is unavoidable on shared-use routes, pedestrian lanes should be differentiated from cycle lanes using delineation e.g. raised, central delineator strip; and appropriate tactile warning surface at the start and end of the route to assist people who are blind or partially sighted. Corduroy tactile paving will indicate to blind or partially sighted people what side to enter – laid perpendicular to the direction of travel on the pedestrian lane and parallel with the direction of travel on the cycle lane. The paving should extend for 2400mm at the entry/exit points and at junctions on both the pedestrian and cycle lanes.

1.2.2.3 Other considerations for shared-use routes

- The use of different ground surface colours and/or material on the pedestrian and cycle lanes can offer additional visual cues.
- A cycle symbol waymarker on the appropriate side at all entry/exit points and any junctions with footpaths or other shared routes is required.
- At crossing points, blister tactile paving should be provided to assist walkers who are blind or partially sighted and the pedestrian crossing should contrast visually with cycle lanes.
- When designing new shared-use routes, consider close proximity to public transport links and local sport hubs e.g. which provide adapted cycle activities that require accessible external routes.
- Safety features are required at interfaces with vehicular traffic where applicable e.g. where route networks merge or cross over an access road or public road. These include hazard signs to warn route users and drivers.
- Clear speed restriction signs displayed along the entire route where applicable e.g. where required to slow cyclists.
- Promote awareness of Code of Practice for using shared-use routes and clearly display this at all entry points.



Segregation on shared-use routes and use of tactile paving
(Images courtesy of Sustrans)



Guidance Signpost

- ▶ Guidance on the use of tactile paving surfaces. Chapters 1, 5 and 7. Department for Transport. 2007.
- ▶ LTN 1/20 Cycling Infrastructure Design. Department for Transport.
- ▶ A Guide to Inclusive Cycling. Wheels for Wellbeing. 4th Edition, 2020.
- ▶ DD CEN/TS 15209:2008. Tactile paving surface indicators produced from concrete, clay, and stone.

1.2.3 External route width

Overview

Generous width is an essential design characteristic of accessible external routes. For general path and trails, space that is comfortable and accessible for people walking or wheeling is required. Where space is shared between walkers, cyclists, people using mobility vehicles and horse riders, the potential for conflict is much greater therefore this should be accounted for by providing additional width to enable safe and convenient use by all.

Recommended Standards

- Minimum range 2000-3000mm width for external routes generally, as this permits clear two-way passage without the necessity for passing places. **Note:** 4000mm preferred for shared-use paths and trails where feasible.
- Minimum 4000mm on shared-use greenways to accommodate a range of activities, mobility scooters and adapted cycles. **Note:** for maximum positive impact 6000-7000mm should be achieved on shared-use greenways where possible and particularly in urban/urban fringe, formal and managed settings.
- Where unavoidable, a reduced minimum route width of 1200mm (1500mm preferred) should be maintained adjacent to localised obstructions on paths and trails.

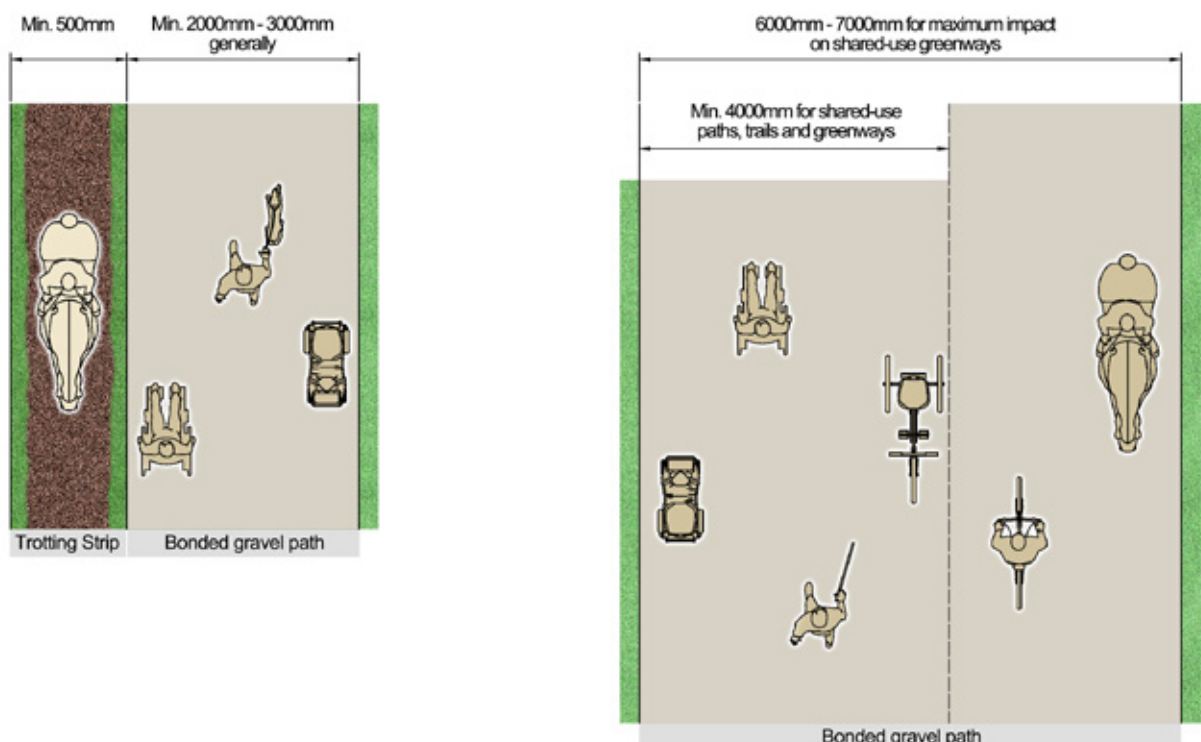

Figure 4 - Accessible External Route Widths

1.2.4 Clear headroom

Overview

Clear headroom must be maintained overhead when walking, wheeling (pushchairs/prams, mobility scooters and wheelchairs), cycling and horse riding. To avoid hazard and injury, it is essential that clear headroom is maintained across the width of an external route e.g. underneath vegetation, signs and manmade structures such as bridges.

Recommended Standards

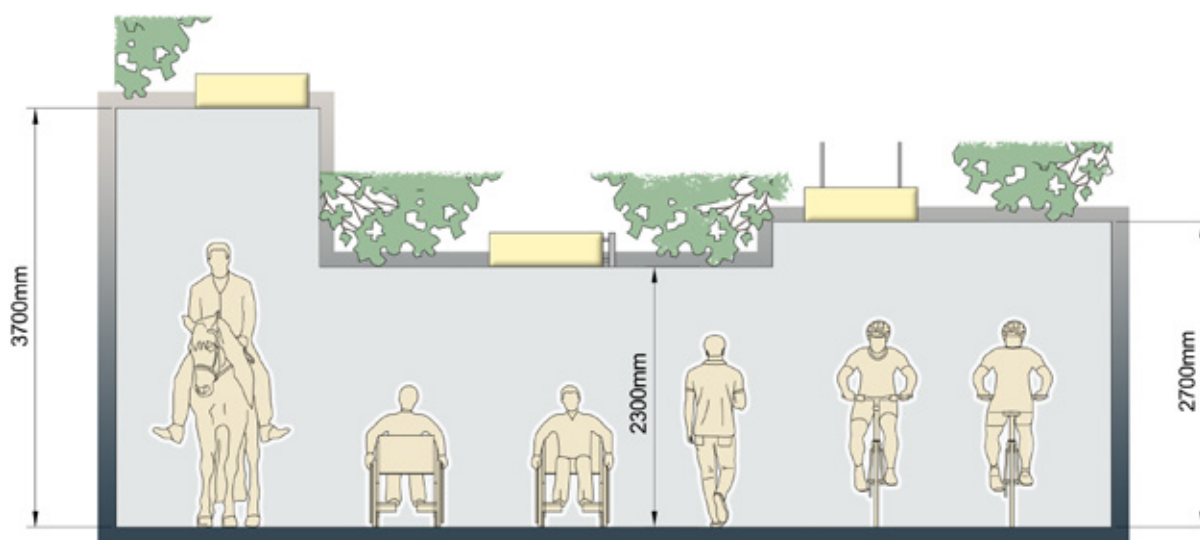

Minimum Preferred Clear Headroom Required
(Structure, vegetation and overhead signs)

Figure 5 - Clear Headroom



Guidance Signpost

- ▶ BS 8300-1:2018. **Paragraph 8.1.2** & Figure 8 Width and height of an access route, p.26-27 & **Paragraph 8.2.2** Provision of hazard protection, p.30-31.
- ▶ Sustrans traffic-free routes and greenways design guide. November 2019: <https://www.sustrans.org.uk/for-professionals/infrastructure/sustrans-traffic-free-routes-and-greenways-design-guide/>

1.2.5 External route ground surfaces



Firm, level bonded surfaces, wide routes and resting places, Victoria Park Belfast



Firm bitmac surface on access bridge, Victoria Park Belfast

Overview

Firm, stable and consistent ground surfaces contribute to the accessibility of external routes. Uneven, waterlogged and muddy surfaces present significant challenges for many users, including parents with pushchairs, people using walking and mobility aids and people who are blind or partially sighted. Loose and angular materials increase potential trip and slip hazards, can be uncomfortable underfoot and can present difficulties when wheeling or horse riding. Ground surfaces should be carefully selected based on proven reliability and tried-and-tested precedent and should be appropriate to the terrain and intended purpose/activity in all weathers.

Note: practical solutions are available to overcome unstable, wet, muddy or bare ground conditions e.g. ground reinforcement grids, synthetic geotextile fabrics and geocomposite drainage systems.

1.2.5.1 Surface materials

Recommended Standards

- Use durable compacted or sealed (i.e. bounded/bonded) materials.
- Ground surfaces should be slip resistant in all weathers.
- To prevent standing water, mud and ice, use a surface material that drains well i.e. a permeable and/or with a finish application to enable water to drain away from the surface. See Section 1.2.9 of this guide: Crossfall and camber.
- Suitable materials, when used in appropriate settings and when carefully selected, can include permeable resin bounded gravel/aggregate, slip resistant resin bonded gravel, concrete and bitmac/asphalt (with adequate drainage measures), stone, timber, paving, composite recycled rubber and compacted/reinforced grass. **Note:** bitmac/asphalt surfaces may be prone to melting in hot weather and potholes in areas of heavy footfall or wet weather.
- Crushed stone must be well compacted where used on external routes.
- Durable surfaces such as recycled rubber and Glass Reinforced Plastic (GRP) are commonly used in outdoor settings.
- Timber provides a natural aesthetic but requires a slip resistant surface to be applied to improve grip e.g. board grooves, bitumen and sharp sand grit or netting (avoid using chicken wire).
- Reflective ground surfaces should not be used e.g. galvanised metal with a matt finish is useful in the context of water-based activities if it also has a slip resistant surface.
- Cobbles, uneven pavements, bare earth, loose sand, bark, chips/stones and unbounded gravels are not considered suitable. **Note:** it may be acceptable to lay a suitable route through a more expansive area of loose material or cobbles to improve access e.g. firm, smooth route through a courtyard or park where cobbles are essential in a heritage setting.
- Grass/turf can be slippery and subject to rutting when wet, or cracking in dry weather. High specification is required for grass to be firm, stable and slip resistant.
- External routes should not have loose materials greater than 5mm in size. This can make the use of some unbounded material compositions such as loose stones and the gravels within 'as dug' surfacing, unsuitable.
- Avoid unfilled joints where possible and, if necessary, joints/gaps should be no more than 5mm wide e.g. joints between pavements, timber boards etc.
- See Section 4.6.3 of this guide: Beach boardwalks and accessible external routes.
- It is essential that external routes are regularly inspected and well maintained to ensure continued accessibility for all users.

1.2.5.2 Considerations when choosing ground surface materials

- Unbounded surfaces such as whin/granite dust can provide a natural aesthetic but if not properly constructed can be subject to waterlogging, movement causing larger loose materials coming through and are problematic on steeper gradients (more suited to level terrain in some settings).
- Semi-bounded surfaces such as Ultitrec®, bind to offer more stability than unbounded surfaces, however, will have more limitations than a fully bounded/bonded route, require edge treatment and time to consolidate.
- The use of boardwalks or bridges can assist with water run-off in poor weather conditions or areas subject to regular flooding or unstable terrain.
- Materials should be sensitive to the setting, to avoid some landscapes becoming unnatural or sterile in appearance. **Note:** using colour or applying surface treatment such as coloured compacted stones can reduce the visual intensity of otherwise harsh ground surfaces in rural and countryside settings e.g. coloured bounded gravel or bitmac/asphalt; and natural discolouration can occur over time also which helps to reduce visual intensity.
- New routes will need time to consolidate where unbounded or reinforced materials are used e.g. as-dug, hoggin self-binding gravel or plastic composite/cellular paving systems.
- Do not install raised horizontal bars as a means of providing slip resistance as these present a potential trip hazard e.g. on smooth concrete or stone paving. A textured or riven surface application is more effective.
- In areas prone to waterlogging or mud, consideration could be given to a stabilising mesh or substructure matting to make the use of grass viable as a natural ground surface. Matting/grids permit grass to grow through providing a firmer and level surface than may be achievable from grass alone. However, it is critical that such material is allowed time to establish and bind, as there is potential for long canes or walking aids to become trapped in the grid holes and prolonged use too early can prevent the grass from growing through at all. Careful monitoring of reinforcement mesh and vegetation growth is required to ensure it matures and binds correctly (where possible this should be permitted prior to any footfall that could restrict growth and binding).
- Any matting should be laid flush within the surrounding surface to prevent potential trip hazard. **Note:** if reinforced grass is not allowed to bind and mature, or there is frequent livestock crossing, the surface of the mesh can become warped or broken and exposed fixing pins can create a potential trip hazard.



Firm, resin bounded gravel surface on wide route with clear edge definition



Well-compacted, firm whin dust ground surface used on level terrain, Portmore Lough Nature Reserve (Image courtesy of RSPB)



Composite rubber surfacing (Image courtesy of Sustrans)



Bitmac route with defined upstand edges at start point of woodland walk



Reinforced grass surface beginning to establish



Guidance Signpost

- ▶ Paths for All Lowland Path Construction Guide. Paths for All and Scottish Natural Heritage. 2019: <https://www.pathsforall.org.uk/mediaLibrary/other/english/lowland-path-guide.pdf>
- ▶ Paths for All Surfacing Guide for Path Projects. Paths for All and Scottish Natural Heritage. 2019: <https://www.pathsforall.org.uk/resources/resource/surfacing-guide-for-path-projects---updated>

1.2.5.3 Temporary ground surfaces

Overview

Temporary surfaces may be necessary to reinforce softer ground/grassed areas subject to waterlogging and/or heavy footfall, including for use during outdoor events. **Note:** existing hardstand and firm ground surfaces should be utilised as much as possible on existing sites and associated facilities sited within close proximity e.g. viewing platforms.

Recommended Standards

- The ground must be prepared with a suitable sub-base to prevent movement, undulations and distortion.
- Provide flush, easy-transition landings at junctions between the temporary surface and the existing ground surface.
- Provide visual contrast between the temporary surface and the existing ground surface.
- Maintain raised fixing bolts clear of the route width.
- On slopes, a form of handrail support installed on both sides will assist ambulant disabled people.
- Remedial measures, such as the use of compacted stone, may be required in areas particularly subject to flooding or waterlog.

1.2.6 Drainage and animal grids



Chiltern Centrewire two-way bridle gate alongside animal grid
(Image courtesy of Centrewire)

Overview

Grids are often installed for drainage or to control the passage of animals onto lands and into play areas e.g. cattle grids and dog grids.

Drainage and animal grids can present a difficulty for people with a variety of mobility difficulties and restrict access for assistance dogs, so should be avoided where possible.

However, where drainage and animal grids are deemed absolutely necessary, the following standards should be applied.

Recommended Standards

- If drainage grids are unavoidable then to meet best practice they should be laid flush with the surrounding ground surface and comprise flat galvanised bars for the comfort of wheeling across the surface; and be hedgehog friendly.
- Provide an accessible by-pass gate adjacent to the grid, including for use by horse riders. Gate hinges should be positioned on the side adjacent to the grid.
- For safety, provide a protective barrier between the grid and the by-pass gate, which extends beyond the grid.
- Where pedestrian gratings are installed on drainage grids, as opposed to an adjacent gate, they should be wide enough to allow safe passage and have slots which will not allow wheels or long canes to get trapped i.e. maximum 13mm wide (maximum 18mm if circular slots are used).
- Gratings made of steel, stainless steel, aluminium or GRP should have a slip resistant, grit-based coating.

- Dished drainage channels should not be installed across external routes. If unavoidable, channels must have a covering that is laid flush with the surface and slip resistant.
- Drainage gullies and grates should be located as far beyond the edge of external routes as possible and, as a minimum, ensure that there is appropriate clear width throughout the length of the route. See Section 1.2.3 of this guide: External route width.
- Drainage gully and grate slots should prevent wheels and long canes getting trapped. Lay slotted gullies perpendicular to the direction of travel, if unavoidable on external routes.

1.2.7 Safety protection on external routes

Overview

It is essential to provide protection from falling where there is a steep drop between an external route and adjacent ground or water. Boundary protection may also be required for safety on external routes adjacent to public roads and around play parks.

Recommended Standards

- Where an external route has a steep exposed edge or bank, provide clearly defined edge treatment. For example, protective guardrails, safety fencing or planting.
- Potential hazards should be clearly marked e.g. using large warning symbol signs.
- Where required to provide a physical boundary, consider the design of boundary fencing and walls to incorporate sensory and rest elements e.g. colours, textures, perch seat.



Comber Greenway – bitmac surface and roadside protective fencing (Image courtesy of IMTAC)

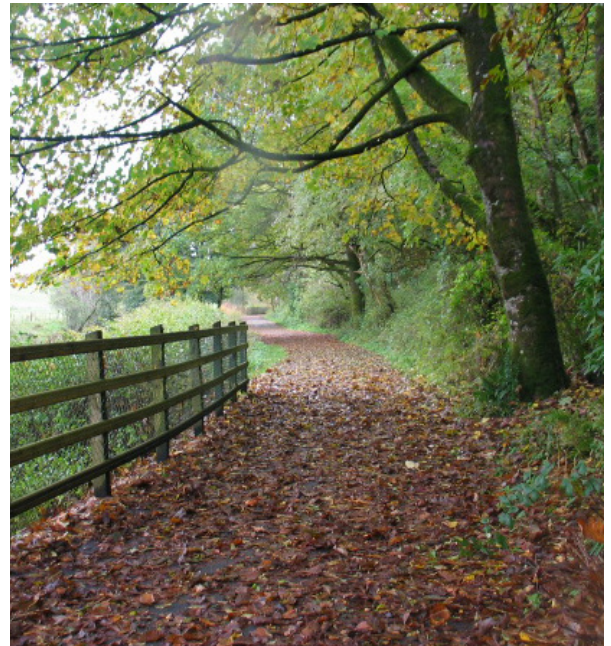

Use of verges, planting banks and safety fencing to protect steep or exposed river edges

1.2.8 Defining external routes

Overview

Providing visually and texturally contrasting ground surfaces and edge treatment to define routes of travel within the landscape assists all users to navigate within outdoor places.

Recommended Standards

- External routes should be clearly defined to assist all users, including people who use long canes.
- Avoid using hard edge treatment e.g. concrete kerb line or timber strips, as over time unsealed surfaces wear below the edge creating a potential trip hazard and can also prevent water run-off. Timber edging has only a limited lifespan. So, as example, woodchip, crushed stone, smooth turf or grass verge minimum 500mm wide. **Note:** where trotting strips are provided adjacent to main routes of travel, the selected ground surface should be suitable for both definition and for horse riding.
- Install 150mm high tapping rails assist people who are blind or partially sighted as an alternative edge treatment, or to complement.

1.2.9 Crossfall and camber

Overview

It is acknowledged that crossfalls and cambers can present difficulties for wheelchair users and people who are blind or partially sighted. Equally, standing water on external routes and landings which can result in puddling and slippery conditions underfoot is problematic and hazardous. As such, crossfalls and cambers help to assist drainage and water run-off but should be as shallow as possible.

Recommended Standards

- The crossfall gradient across the width of an external route, including on ramps, boardwalks and bridges, should be maximum 1 in 50 (1 in 100 preferred), except when associated with a dropped kerb or an adjacent level resting place.
- A camber on an external route i.e. sloped from the centre of the route downwards to the sides, should be maximum 1 in 40.
- Landings on external routes, ramps and steps should also have a crossfall or a means of drainage to avoid standing water.

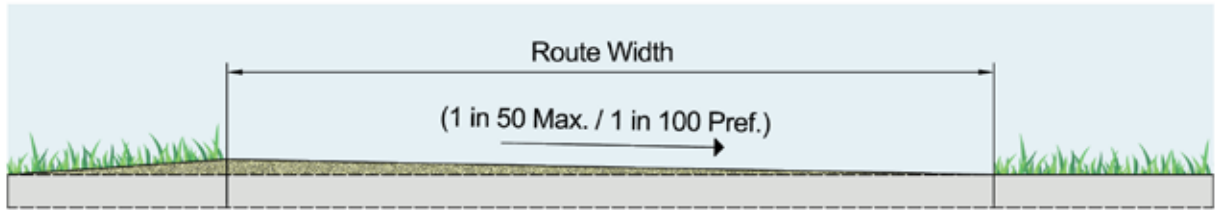

Creating a crossfall on an external route in flat terrain

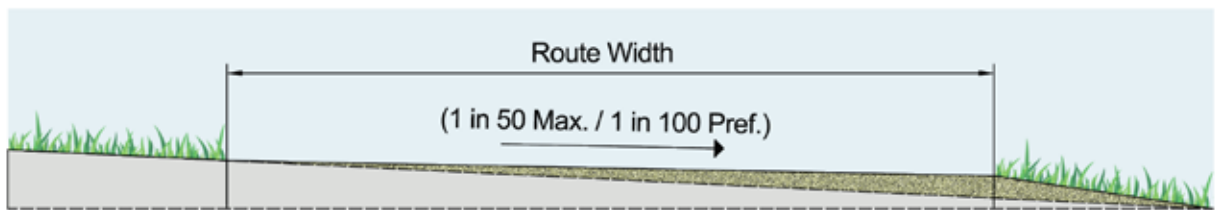

Creating a crossfall on an external route where existing terrain exceeds crossfall requirements

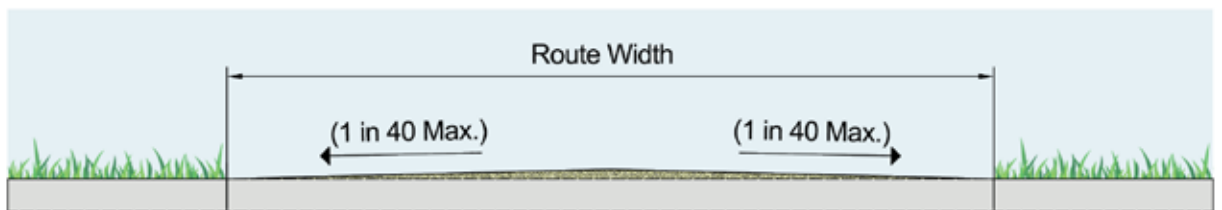

Creating a camber on an external route in flat terrain

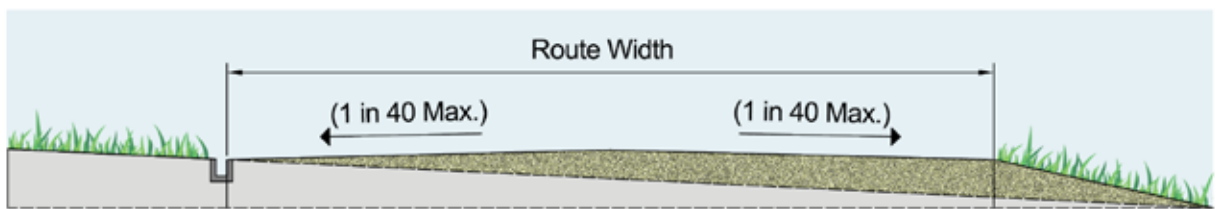

Creating a camber on an external route where existing terrain exceeds crossfall requirements

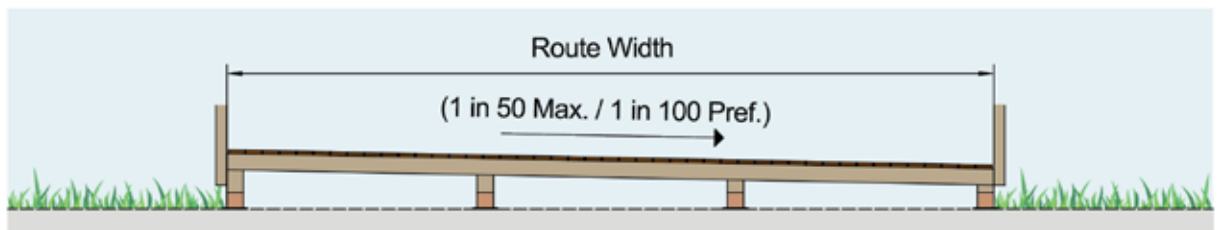

Creating a crossfall on boardwalks, ramps and bridges

Figure 6 - Crossfall and Camber

1.2.10 Passing places

Overview

An accessible external route should be wide enough to allow clear passage without the need for passing places i.e. 2000mm. In some settings, it is recognised that this may be difficult to achieve, either along a route in its entirety or partially. As such, suitably designed passing places should be provided. Passing places can offer an opportunity for respite where they include seating.

Recommended Standards

- Provide passing places only where paths are less than 2000mm wide.
- Passing places should be 25-50m apart.
- A passing place should be within direct sight of another.
- Passing places should be 2000mm wide by 2000mm long.
- See Figure 14 of this guide: Features of an Accessible External Route.

1.2.11 Boardwalks and bridges

Overview

Boardwalks and bridges can be particularly useful to provide a firm, safe and accessible external route across areas where ground is unstable or prone to flooding.

Recommended Standards

- If placed on rough ground or ground prone to waterlog, boardwalks should be supported with load bearing stabilisers to prevent movement and instability.
- Boardwalks and bridges over 25m in length will require passing places or be of adequate width to negate this e.g. for one-way traffic minimum 1200mm wide and minimum 2000mm for two-way traffic.
- Provide a slip resistant, robust surface finish. See Section 1.2.5 of this guide: External route ground surfaces.
- Boardwalks should be level or gently sloping along their length.
- Provide maximum 1 in 50 crossfall.
- Where boards are used, spacing of joints/gaps between boards should be no more than 5mm wide and boards should be laid perpendicular to the line of travel.
- Provide edge protection minimum 100mm high e.g. timber beam board.
- Handrails should be installed on both sides. See Section 1.6 of this guide: Handrails.
- Provide smooth transition from the external route to the boardwalk or bridge, with level access onto the boardwalk maximum 15mm high.
- To assist birdwatchers, boardwalks should incorporate a layby with seating positioned opposite the handrails (which act as rainwater troughs for birds to drink from).
- Sleeper bridges should be minimum four sleepers wide and the spacing of joints/gaps between sleepers no more than 5mm wide.
- See Section 4.6.3 of this guide: Beach boardwalks and accessible external routes.



Accessible boardwalk at RSPB Portmore Lough Nature Reserve (Image courtesy of RSPB)



Bridge over uneven ground, with gently sloped transition area



Boardwalks with edge upstands over wet ground/dipping pond (Images courtesy of The Wild Deck Company Ltd)



Boardwalk with resting places and shelter (Image courtesy of The Wild Deck Company Ltd)



Wide bridge with edge upstands and circular profile rope handrails (Image courtesy of The Wild Deck Company Ltd)

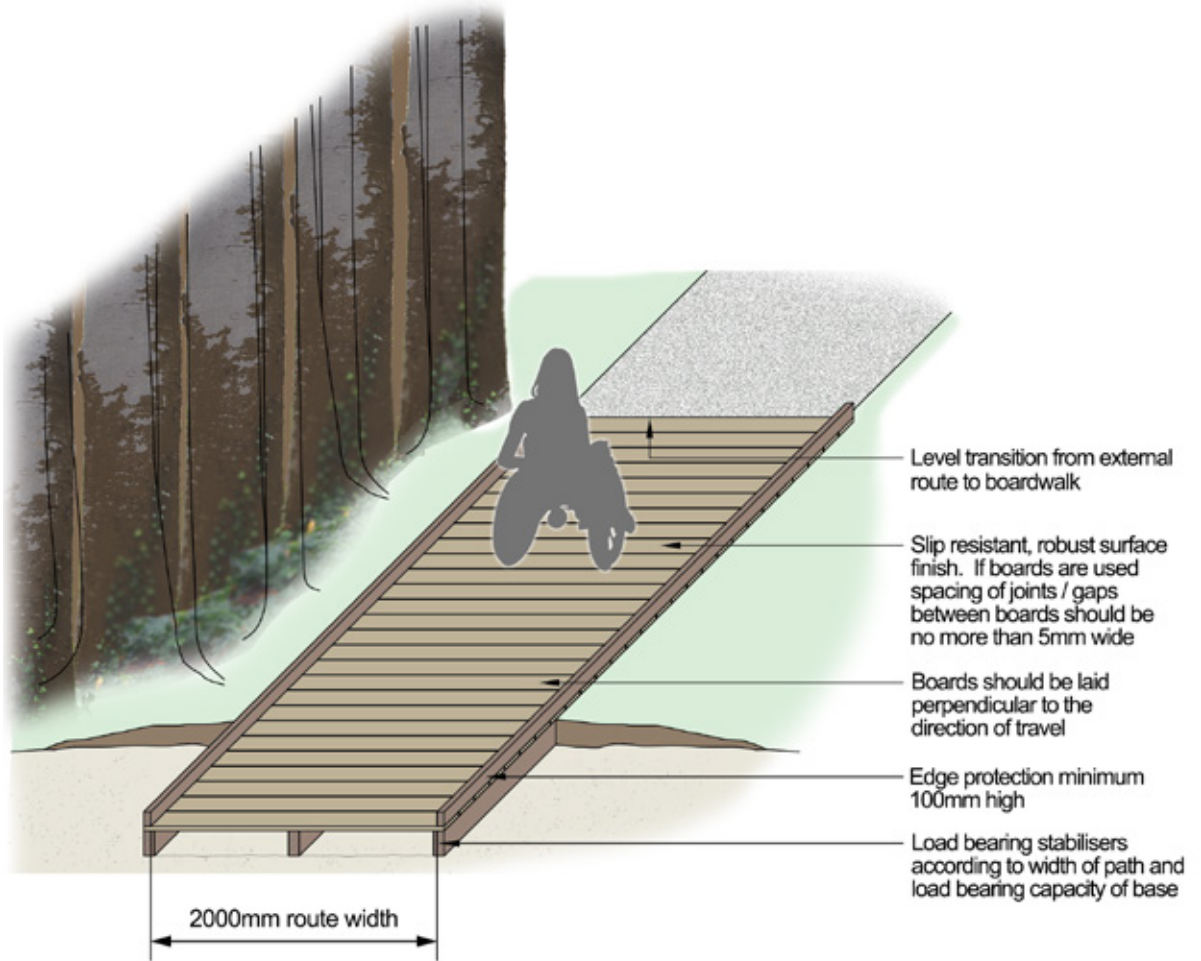

Boardwalk on unstable ground

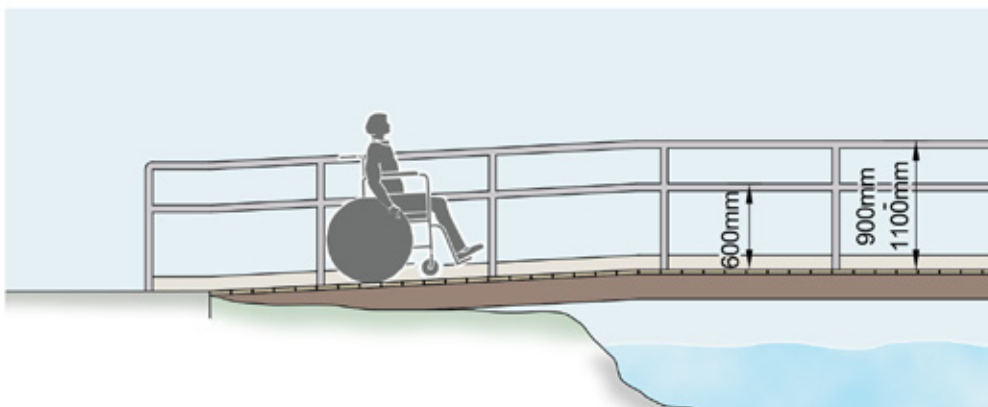

Figure 7 - Typical Boardwalk and Bridge

EZ Trail® floating dock walkways

As an alternative to boardwalks, the EZ Trail® system from EZ Dock is a way to create accessible ramps and routes through woodland or wetland where a firm, durable walking platform is required to address difficult terrain. It uses a lightweight modular system to form stable walkway routes across unstable terrain.



EZ Trail® walkway (Images courtesy of EZ Dock)



Guidance Signpost

- ▶ EZ Trail®: <https://www.ez-dock.com/market/ez-trail/>

1.2.12 Slip resistance

- Ground surface materials should give a wet PTV (pendulum test value) greater than 40 to facilitate wheeling and turning.
- A sloping surface needs to have a higher coefficient of friction than an equivalent level surface to maintain the same degree of traction. Where an external ramp is likely to become wet, the recommended wet PTV for ramps is increased to 45 for ramp gradients 1 in 20 and to 49 for the steepest ramp gradient 1 in 12.
- A PTV greater than 36 is considered to be suitable for step nosings and treads, as wheeling and turning are unlikely on steps. **Note:** on existing step nosings, slip resistance is denoted in terms of Rz (roughness value) and an Rz value of 20µm is considered to be acceptable.



Guidance Signpost

- ▶ BS 8300-2:2018. **Annex C** (informative) Slip potential characteristics of treads, ramp surfaces and floor finishes, p.179-180.

1.2.13 Designing for walkers and cyclists who are blind or partially sighted

Overview

Visiting outdoor places can present particular challenges for people who are blind or partially sighted. As these challenges are often overlooked in the design of accessible outdoor places, advice for accommodating walkers and cyclists is as follows:

- Settings, such as natural heritage sites and open, rugged terrain are often expansive and unpredictable, prone to rapid changes in weather conditions and lighting levels. A clear network of accessible routes through a large expansive open space provides reassurance when perhaps there are no other permanent landmarks with which to navigate.
- Using a prominent natural or manmade feature or landmark at the beginning of walking routes to denote the starting point (and/or end point) and as a meeting point tool is helpful.
- A long cane user requires minimum 1200mm clear width to pass other route users and can detect objects lower than 675mm above ground level. Any object mounted between 675mm and 2500mm above ground level must not project more than 100mm into a route e.g. an information display board.
- Tactile cues are useful to inform a person who is blind or partially sighted that there is a particular feature of interest or hazard ahead e.g. a rest seat location, Braille/audio post, tactile information board etc. Where provided these should be installed the width of the route, no more than 400mm prior to the feature and 800mm in length. Any material used should contrast with the surrounding external route finish, be securely fixed and must not create a potential trip hazard (maximum lip 5mm). Where 'Information Surface' is used, it should be laid flush with the external route finish. Any joints/gaps between timber boards slabs or pavements used as the tactile cue material should be maximum 5mm. If tactile warning surface comprising a raised corduroy strip profile is used to denote a hazard, it should contrast with the surrounding external route finish (not red) and the strip profile should be laid perpendicular to the direction of travel.
- An interruption in edge treatment or tapping rail on a route can give advance notice of a pending feature or hazard.
- Guide railing can serve as an orientation tool leading to specific sensory features of interest e.g. water feature.
- External route information, pre-visit and along the route could highlight:
 - Potential barriers or obstacles, including those at eye level and underfoot e.g. areas of rough ground, rivers, steppingstones, animal grids, steep changes in level; and the measures provided to overcome them e.g. symbols for bridges, ramps etc.

- Permanent landmarks, which can be a useful navigation tool.
- Historical or manmade landscape, tactile points of interest, features, wildlife and vegetal information.
- Provisions for assistance dogs.
- Listening posts relay animal and bird sounds to animate local wildlife and can describe views.
- The Ramble Tag® guidance aid enables people who are blind or partially sighted to enjoy a variety of outdoor places more safely when accompanied by a guide, if that is their preference. It offers an alternative means of guiding than holding an elbow or linking an arm and can reduce the necessity for some people to otherwise use a wheelchair or mobility scooter in challenging settings.



Ramble Tag® guidance aid for open walks and outdoor adventure
(Images courtesy of Ramble Tag®)



Guidance Signpost

- ▶ British Blind Sport: <https://britishblindsport.org.uk/wp-content/uploads/2018/11/VisualImpairmentGuidance-November2018-2.pdf>
- ▶ Sensing Nature Project. Designing urban green space with sight impairment in mind. Dr Sarah Bell. University of Exeter and Economic and Social Research Council. 2017.
- ▶ Sensing Nature Project and VocalEyes. Supporting multisensory visitor experiences at natural heritage settings. Audio description and access guidance for staff and volunteers.
- ▶ Guidance on the use of tactile paving surfaces. Chapters 1, 5 and 7. Department for Transport. 2007.
- ▶ DD CEN/TS 15209:2008. Tactile paving surface indicators produced from concrete, clay, and stone.
- ▶ Ramble Tag: www.rambletag.co.uk

1.3 Barriers and Obstacles on External Routes

Overview

Barriers and obstacles on external routes can render them inaccessible to many people, therefore careful consideration should be given to whether manmade barriers, such as gates or steps, are required at all. It is important to acknowledge that natural barriers and obstacles can be evident on an existing or potential route e.g. trees, narrow passages, shrubbery, natural gradients, rocks and logs. Natural barriers or obstacles must be assessed when designing or improving external routes to overcome them and to ensure minimum clear width is achieved, the route is adapted by removing the barriers or obstacles where possible e.g. clearing shrubbery and logs, or an option of walking or wheeling around them.

Increasingly off-road mobility scooters, cross-country wheelchairs and all-terrain vehicles are used to access the outdoors, including challenging terrains such as hills, shallow water and uneven ground. The design of accessible external routes should account for these mobility vehicles, with careful thought given to the necessity and design of any new manmade barriers, or adaptations to existing manmade or natural barriers.

Recommended Standards

- When designing or specifying a fixed structure and the approach to it, consider site purpose, anticipated users/activities, access needs, adequate width and space to turn.
- Follow guidance within British Standard BS 5709:2018 Gaps Gates and Stiles when considering the design of gaps and gates i.e. adopting the least restrictive option (including replacement of existing barriers) in conjunction with suitable ground surface, avoidance of hazards and sufficient space to close a gate. **Note:** the least restrictive option should preferably mean no manmade barrier at all i.e. no steps, stiles or other physical barriers.
- Where unavoidable, manmade barriers should provide space for larger mobility vehicles to enable users to position their approach to a gate assisted or unassisted, to pass through a fixed barrier, or to open, pass through and close a gate.
- If a manmade barrier is likely to limit or restrict access for some people e.g. horse riders, scooter users and assistance dog owners, a suitable alternative adjacent is required e.g. two-way side-hung gate, slope to complement steps, stile with dog pass-through section, alternate or by-pass route.
- Any barrier should be located on firm, level ground clear of vegetation overgrowth.
- Describe any obstacles or barriers in pre-visit and on-site information.

- Barbed wire and electric fences should be avoided. Where necessary, they should be highly visible on approach. Protective tubing should be attached to the fence to prevent users coming into contact with the fence at any point where crossing of the boundary is required. Contrasting fence posts alongside appropriate tactile and/or auditory advanced warning signals are required.
- Rope barriers across external routes are dangerous, particularly for people who are blind or partially sighted and should be avoided e.g. elasticated ropes used to cordon off a section of ground that allows animals to cross. As a minimum, ropes should be distinguishable and complementary advanced warning signs used adjacent or attached to the ropes to make them more visible on approach.

1.3.1 Gaps

Overview

A gap is a clear opening through a hedge or site boundary.

Recommended Standards

- Where barriers are unavoidable, a gap is preferable to a gate as a means of least restrictive access and should be designed to accommodate the passage of disabled walkers and wheelers.
- Gaps on an external route should be minimum 1200mm wide (1500mm preferred).

1.3.2 Gates

Overview

For various reasons, including the restriction of livestock movement and vehicular access, often gates are considered necessary on an external route. However, gates can present a barrier for disabled people, including people using mobility vehicles. Careful consideration should be given to whether gates are necessary when designing or designating external routes. If unavoidable, gates should be designed to enable clear passage and easy opening.



Aston Centrewire gate with easy open latch and 1700mm overall width; robust bottom rails make it suitable for mobility vehicles (Image courtesy of Centrewire)



Henley Centrewire bridle gate with easy open latch and 2100mm overall width (Image courtesy of Centrewire)

Recommended Standards

- If a gap is not suitable and a gate must be installed, a two-way, non-sprung self-closing gate with easy open latch provides the easiest access. Section 1.3.2.2 of this guide: Gate opening mechanism.
- Gates on an external route should be minimum 1200mm wide (minimum 1500mm preferred). See Section 1.3.2.1 of this guide: Space at gates.
- Provide signs on gates to indicate that they are accessible and that obstructing gates is prohibited.
- Gates should enable clear visibility on approach from either direction in a seated or standing position.
- The maximum force required to open a gate should be 22.5 newtons.
- Self-closing gates require a minimum eight second time lapse for clear passage e.g. to assist horse riders using bridle gates.
- Where field gates are necessary to restrict livestock movement or vehicular access, an alternate complementary gate should be provided adjacent to it, as although field gates offer a good clear width, they are often heavy and difficult to operate.

1.3.2.1 Space at gates

Recommended Standards

- To approach and release a gate which opens towards the user will require minimum 500mm clear width adjacent to the latch side of the gate and minimum 2000mm length, to ensure the user does not have to leave the defined external route.
- Avoid dead-ends and the need to turn on external routes, however, if turning is unavoidable, adequate space for self-propelled and larger electrically propelled wheelchairs, off-road mobility scooters and all-terrain vehicles should be provided.
- Space at gates 2500mm wide by 2800mm long is recommended to ensure the broadest range of need is accommodated. **Note:** based on the following:
 - Category 3 mobility scooters are accommodated by a turning space minimum 850mm wide by 1730mm long.
 - A range of mobility scooters are accommodated by a turning space 2200mm wide by 2800mm long.
 - Most electrically propelled wheelchairs are accommodated by a turning space 1600mm wide by 2150mm long.*

- A 2500mm turning circle accommodates electric mobility scooters turning through 90 degrees e.g. at a route junction.*
- A 1800mm turning circle accommodates a companion turning a wheelchair user manually through 90 degrees.*

*Taken from BS 8300-2: 2018 Annex G (informative) Space allowance for wheelchair manoeuvring, p.194-199.

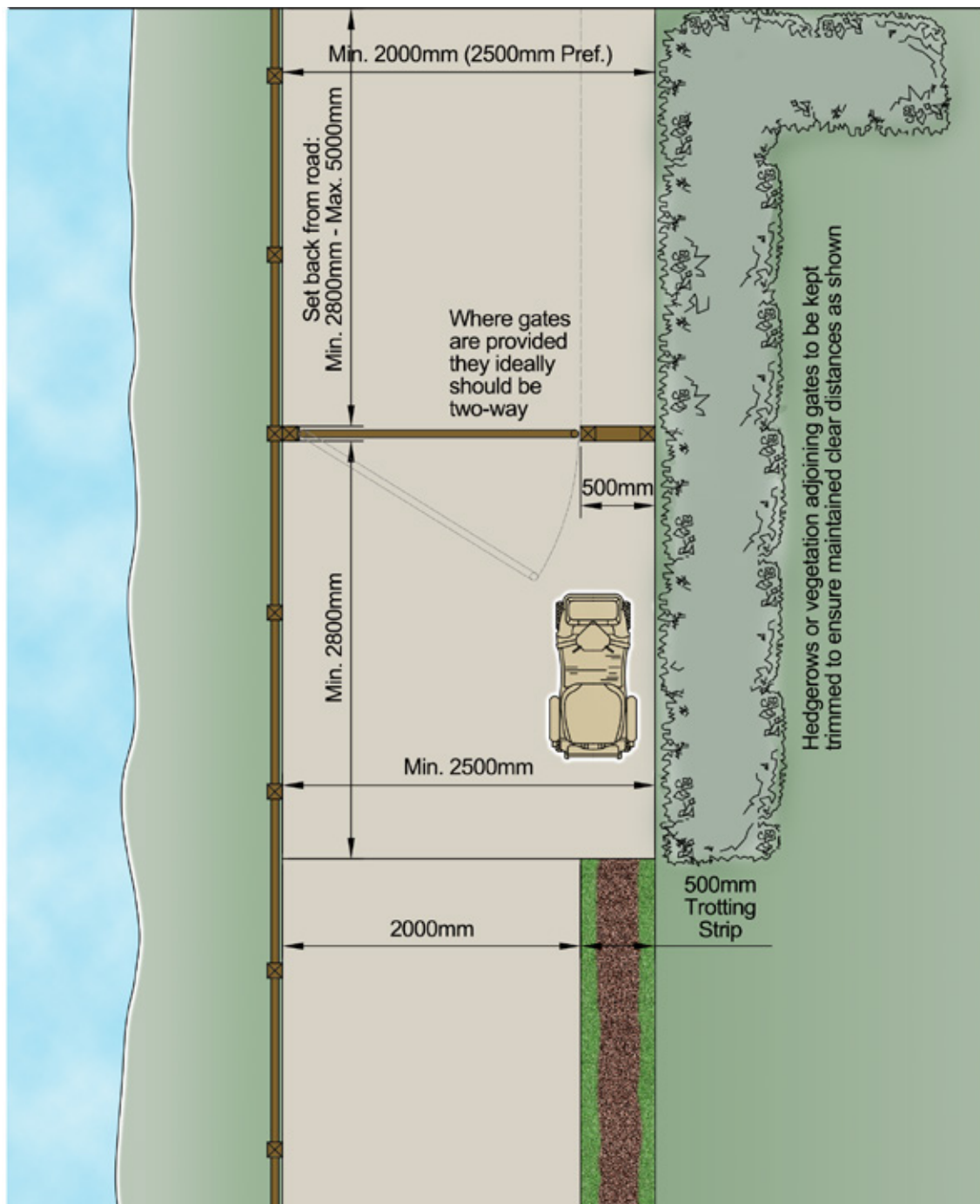

Figure 8 - Space at Gates

1.3.2.2 Gate opening mechanism



Easy open latch mechanism with contrasting, textured handle (Image courtesy of Centrewire)

Recommended Standards

- Choose a self-closing latch which is easy to open from both sides using either hand and with minimal dexterity (no twist-turn or pinch action).
- A trombone-style handle and Centrewire* easy open latch mechanism is suitable.
- A contrasting yellow handle ensures the easy open latch mechanism is clearly visible and usable parts on a latch should be textured.
- Easy open latches should be operable at a range of height (600-1000mm above ground level preferred; maximum 1200mm).
- Any latch handle should be minimum 100mm in length have a 20-30mm circular diameter profile.
- Note: examples of when site managers have deemed the use of RADAR locks on gates necessary include:
 - For security purposes to restrict vehicular access (whilst retaining accessibility for disabled people).
 - Where a kissing gate is installed (whilst enabling off-road mobility scooter access beyond the limits of the gate's metal enclosure).

Notwithstanding, RADAR locks on gates should be avoided as far as possible. See Section 2.8 of this guide: RADAR Locks.

*<https://www.centrewire.com>



Milton Keynes Centrewire gate with contrasting latch and hardstand either side (Image courtesy of Centrewire)

1.3.3 Kissing gates



Woodstock Centrewire kissing gate, fitted with RADAR lock "RADLOCK latch system" (Image courtesy of Centrewire)

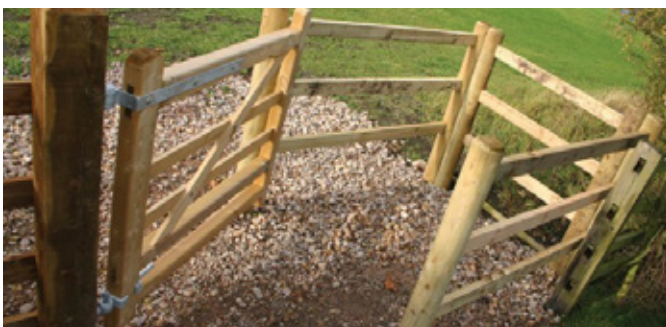

Oxford timber Centrewire mobility kissing gate (Image courtesy of Centrewire)



Parkland Centrewire kissing gate (Image courtesy of Centrewire)

Overview

Kissing gates are often chosen for security reasons to restrict vehicular access e.g. quadbikes and cars. Unsuitable kissing gates can present a barrier to people using mobility aids, off-road mobility scooters and all-terrain vehicles.

Recommended Standards

- Kissing gates should be avoided, with preference given to having no fixed barrier on an external route at all, a gap, or as a minimum a two-way, non-sprung self-closing gate.
- If a kissing gate is determined to be the only option, an accessible kissing gate should be installed. **Note:** this may still be inaccessible for some larger off-road mobility vehicles.
- Fit a toe board edge rail for protection.

1.3.4 Stiles

Overview

Stiles are challenging for disabled people and will render an external route inaccessible for many disabled people.

Recommended Standards

- Stiles should be avoided on new external routes.
- Consider replacing stiles on existing external routes with a more suitable option (preferably no barrier at all).
- Where unavoidable, stiles should incorporate a dog pass-through section to assist owners of assistance dogs.

1.3.5 Staggered barriers

Overview

Often on shared-use external routes, measures imposed for the benefit of some users or as an access deterrent can negatively impact others e.g. staggered cyclist speed barriers/chicanes or A-frames present a barrier for mobility scooter or all-terrain vehicle users, wheelchair users, horse riders and people using adapted cycles.

Recommended Standards

- Where staggered barriers are absolutely necessary e.g. to prevent off-road vehicles from merging with vehicles on an access road or public road, staggered barriers/chicanes should have a gap minimum 1500mm wide to allow clear unimpeded passage of mobility scooter and all-terrain vehicle users, wheelchair users, horse riders and people using adapted cycles.

- Any width restriction should be maintained no less than 1500mm high above ground level (preferably for the entire height of the barrier i.e. should not taper).
- The first panel/gate should be located on the nearside of the route to encourage greatest speed reduction before a change in direction.
- **Do not overlap** panels/gates, as this can cause difficulty for mobility scooter and all-terrain vehicle users, wheelchair users, horse riders and people using adapted cycles.

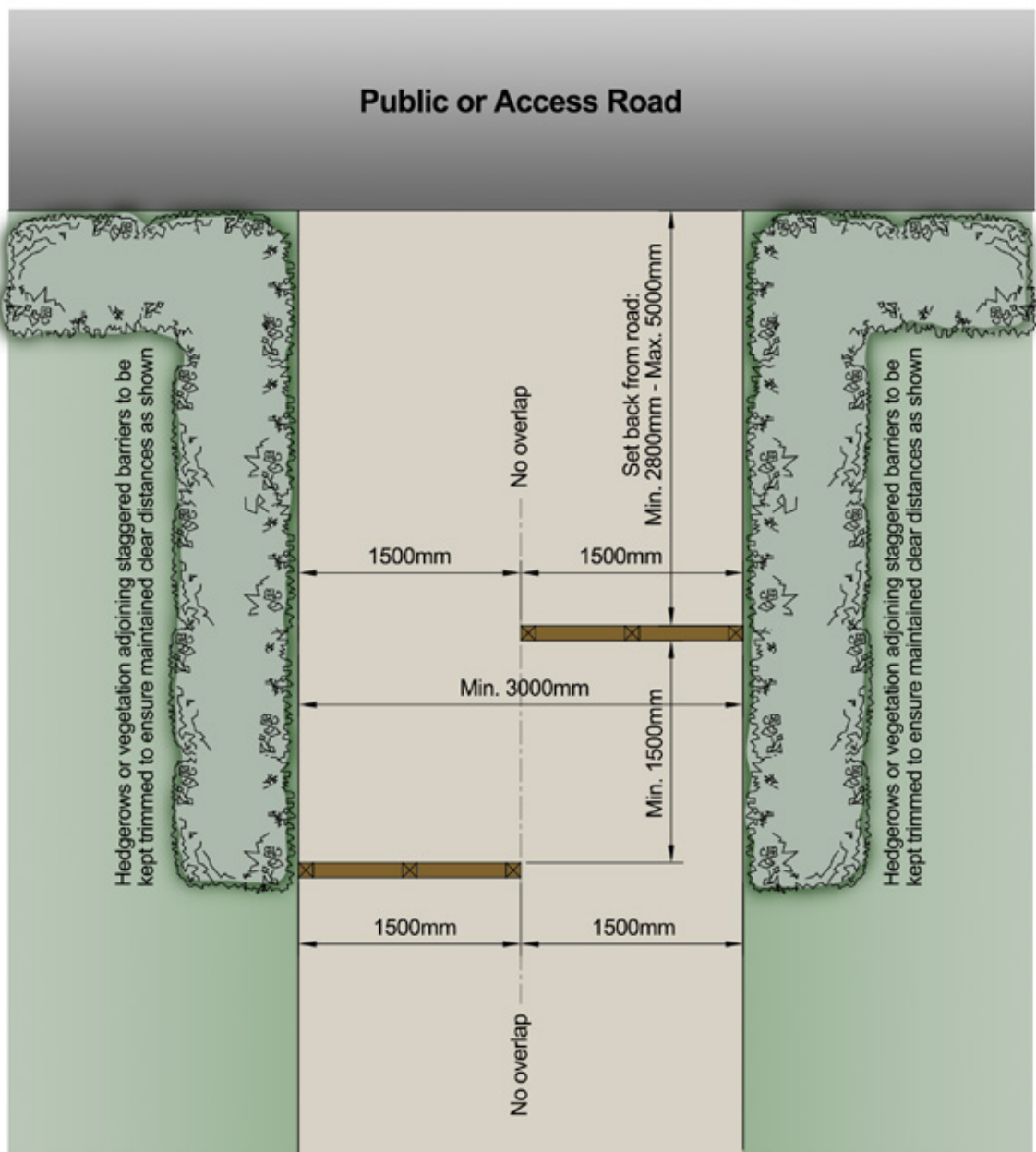

Figure 9 - Staggered Barriers

1.3.6 Steppingstones

Recommended Standards

- On new routes, provide a boardwalk or bridge. See Section 1.2.11 of this guide: Boardwalks and bridges.
- On existing routes and in historic locations, complement steppingstones with a suitable alternative in close proximity e.g. bridge.

1.3.7 Other obstacles on external routes

Recommended Standards

- Bollards should be avoided.
- Where bollards are necessary for security purposes, provide minimum 1200mm clear width between bollards to accommodate adapted cycles and larger off-road mobility vehicles used by disabled people (minimum 1500mm preferred).
- Where bollards are used, they should be minimum 1000mm high.
- Bollards should contrast visually against the background in which they are seen, comprise a non-reflective material and have a minimum 150mm deep visually contrasting/reflective band to the top to enhance visibility at all times, including at night.
- Furniture such as lamp posts, signposts, litter bins, seating and cycle stands should be located beyond the edge of external routes ensuring that there is a minimum clear width throughout the length of the route. See Section 1.2.3 of this guide: External route width.
- Bins should be minimum 1000mm high, with an opening at 1000mm above ground level. It should be possible to detect bins at ground level as opposed to mounted high onto lamp posts, to assist people using long canes.
- Trees, planting and soft landscaping features should not be located within the clear width of an external route, including along 'desire lines' i.e. "shortest or most easily navigated pedestrian route between an origin and a destination" (BS 8300-1:2018).
- Avoid tree gullies and instead use a permeable paving surface, with easy transition flush with the surrounding ground surface.
- Overhanging branches and tree roots should not cause obstruction and should be removed where possible, or by-passed, to ensure safety.
- Surface or ground-mounted tree pits should provide a smooth transition and accessible surface from the surrounding ground level/finish.

1.3.8 Dropped kerbs

Recommended Standards

- Tactile paving should be used to provide warning and guidance to people who are blind or partially sighted when approaching a dropped kerb, or at a crossing point on external routes.
- There are different types of tactile paving for different situations and it should be selected appropriately depending on the hazard warning and guidance information required.
- External routes designed to include cyclists should have dropped kerbs where required, minimum 1500mm wide.



Use of tactile blister paving where external routes meet junction with car park
(Image courtesy of RSPB)



Guidance Signpost

- ▶ British Standard BS 5709:2018. Gaps Gates and Stiles.
- ▶ The Access to the Countryside (Northern Ireland) Order 1983:
<https://www.legislation.gov.uk/nisi/1983/1895/contents>
<https://www.nidirect.gov.uk/articles/public-rights-way>
- ▶ BS 8300-1:2018. **Paragraph 8.5** Gates, Barriers and Restrictions, p.34-35.
- ▶ BS 8300-1:2018. **Paragraph 8.2.1.2** Low level walls and free-standing posts and columns, p.28-29.
- ▶ DEFRA Good Practice Guidance on Public Path Structures. Guidance for local authorities on compliance with the Equality Act 2010. October 2010.
- ▶ Derry City & Strabane District Council Green Infrastructure Plan 2019-2032.
- ▶ Guidance on the use of tactile paving surfaces. Department for Transport. 2007.
- ▶ DD CEN/TS 15209:2008. Tactile paving surface indicators produced from concrete, clay, and stone.
- ▶ National Land Access Centre video link:
<https://www.youtube.com/watch?v=Za6ll9Vzfuc>

1.4 Sloped Gradients and External Ramps on External Routes

Overview

Sloped gradients and ramps should be avoided on accessible external routes. They can present too great a challenge to some disabled people who may have reduced upper body strength and assistance may be required by people using manual wheelchairs or those who tire easily. Similarly, a companion pushing a wheelchair may find this difficult. Steep downward slopes can be particularly hazardous should they cause a wheelchair user or scooter user to fall forwards, lose control or be unable to brake. Level areas or ramp landings are essential to provide respite on slopes and ramps.

1.4.1 Slope and ramp gradient

In general, the following categories apply in relation to sloped gradients:

- A gradient of 1 in 60 or shallower is considered to be level.
- A gradient between 1 in 60 and 1 in 21 is considered to be gently sloping.
- A gradient 1 in 20 or steeper is considered to be a ramp and should be in accordance with ramp standards.
- A step-free route is without steps but may include a ramp.

Recommended Standards

- External routes should be level or have the lowest practicable sloped gradient and maximum 1 in 21. Only where terrain dictates that a level or gently sloping gradient is not achievable, may route sections have steeper slopes.
- A gradient 1 in 20 or steeper is considered to be a ramp and should be in accordance with ramp standards, including handrail support. The gradient of a ramp flight in relation to its length should be not steeper than that shown in BS 8300-1: 2018 Table 3, p.40 e.g. no individual flight of a ramp should have a going greater than 10m or a rise of more than 500mm, or an external route should not have a gradient/hills any steeper than 1 in 12 over a short distance (maximum 1 in 15 preferred) i.e. maximum length of 2000mm between landings with a maximum rise of 166mm in any flight. **Note:** except in exceptional circumstances within urban/urban fringe, formal and managed settings where topography dictates this cannot be achieved, after full exploration of all options and supportive evidence is collated. **Note:** except in exceptional circumstances across rural, farmland and forest landscapes, or open and wild countryside.
- Where ramps are installed to address a change in level minimum 300mm, external steps should be provided to complement.

Slope and Ramp Gradient

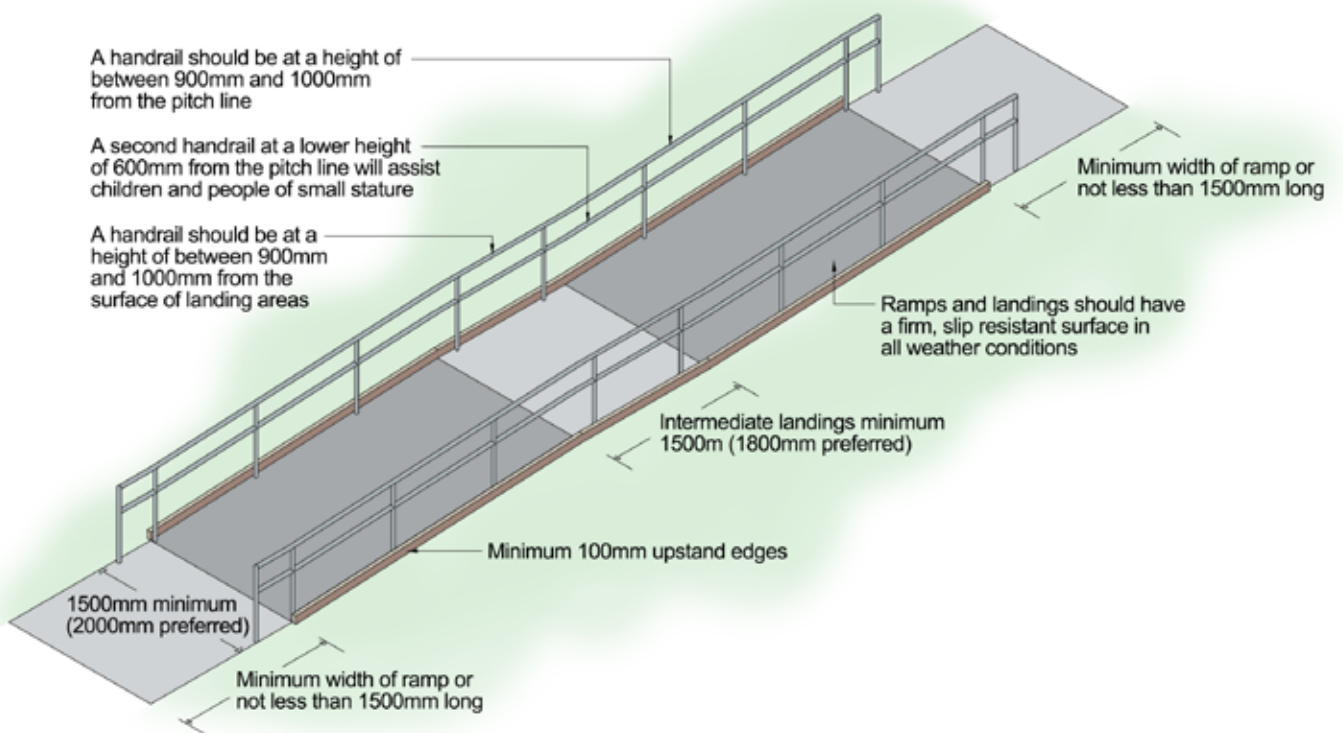
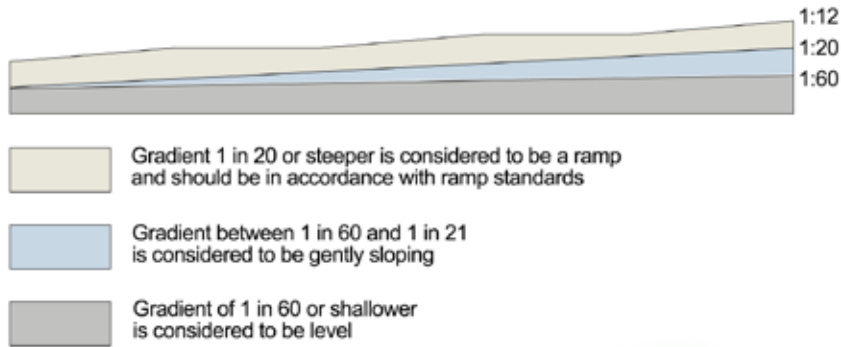

Figure 10 - External Slopes and Ramps

1.4.2 Ramp width and surface

Recommended Standards

- The surface width of a ramp, between features such as walls and edge upstands and handrails should be not less than 1500mm (minimum 2000mm preferred for two-way traffic in the external environment and to avoid the need for passing places on a long ramp).
- It is not essential that wider ramps are divided however, where wider ramps are divided, no section should have a surface width less than 1500mm.
- Ramps should not intersect a flight of steps as this will create a tapered riser.
- Provide minimum 100mm high contrasting edge upstands to prevent castors veering over the edge and to assist people using long canes. **Note:** a separate upstand is not necessary where solid guarding is installed, or where open guarding incorporates a continuous bottom rail minimum 100mm high above the ramp flight.
- The flight surface should contrast visually against the edge upstands and top, bottom and intermediate landings, to assist people who are blind or partially sighted.
- Ramps should have a firm, slip resistant surface in all weather conditions. The use of integrated heating cables can overcome the problem of ice. See Section 1.2.12 of this guide: Slip resistance.
- Where different materials are used for ramp flights and landings, they must comprise similar frictional characteristics to reduce potential trip hazard.
- Where possible on frequently used ramps, provide weather protection in the form of a canopy or overhang.
- See Section 1.2.9 of this guide: Crossfall and camber.

1.4.3 Level areas and landings

Recommended Standards

- Where an external route has a gradient between 1 in 60 and 1 in 21, it should preferably have a level landing for respite for each 500mm rise. **Note:** where an external route has a gradient less steep than 1 in 30, a level respite adjacent to the route may be acceptable.
- Where an external route has a gradient 1 in 20 or steeper it is a ramp, whereby gradient is considered in conjunction with length and intermediate level landings are required between maximum permissible flight lengths, minimum 1500mm long (1800mm preferred).

Note: except in exceptional circumstances within urban/urban fringe, formal and managed settings where topography dictates this cannot be achieved, after full exploration of all options and supportive evidence is gathered. **Note:** except in exceptional circumstances across rural, farmland and forest landscapes, or open and wild countryside.

- A level area or ramp landing should be installed wherever a change of direction occurs and clear of any obstruction/obstacle. This should be minimum 1500mm long or the width of the ramp (2800mm preferred, to enable mobility scooter users to turn).
- Level landings should be provided at the top and bottom of a ramp, minimum width of the ramp and not less than 1500mm long, clear of any obstruction.
- Where ramps comprise more than three flights, or on ramps where the top of the ramp is not clearly visible from the bottom (and vice versa), intermediate landings minimum 1800mm by 1800mm are required as passing places (minimum 2000mm by 2000mm preferred).



Guidance Signpost

- ▶ BS 8300-1: 2018. **Paragraph 9.2** Ramps, p. 39-42.
- ▶ By All Reasonable Means. Least restrictive access to the outdoors. A guide produced by the Sensory Trust in collaboration with, and on behalf of, Natural Resources Wales. December 2017.

1.5 Steps on External Routes

Overview

Changes in level and external steps can present a barrier to disabled people in the external environment. They should be avoided and consideration given to alternatives and replacement when developing new external routes or improving existing external routes.



Steps and alternative sloped route adjacent
(Image courtesy of Sustrans)

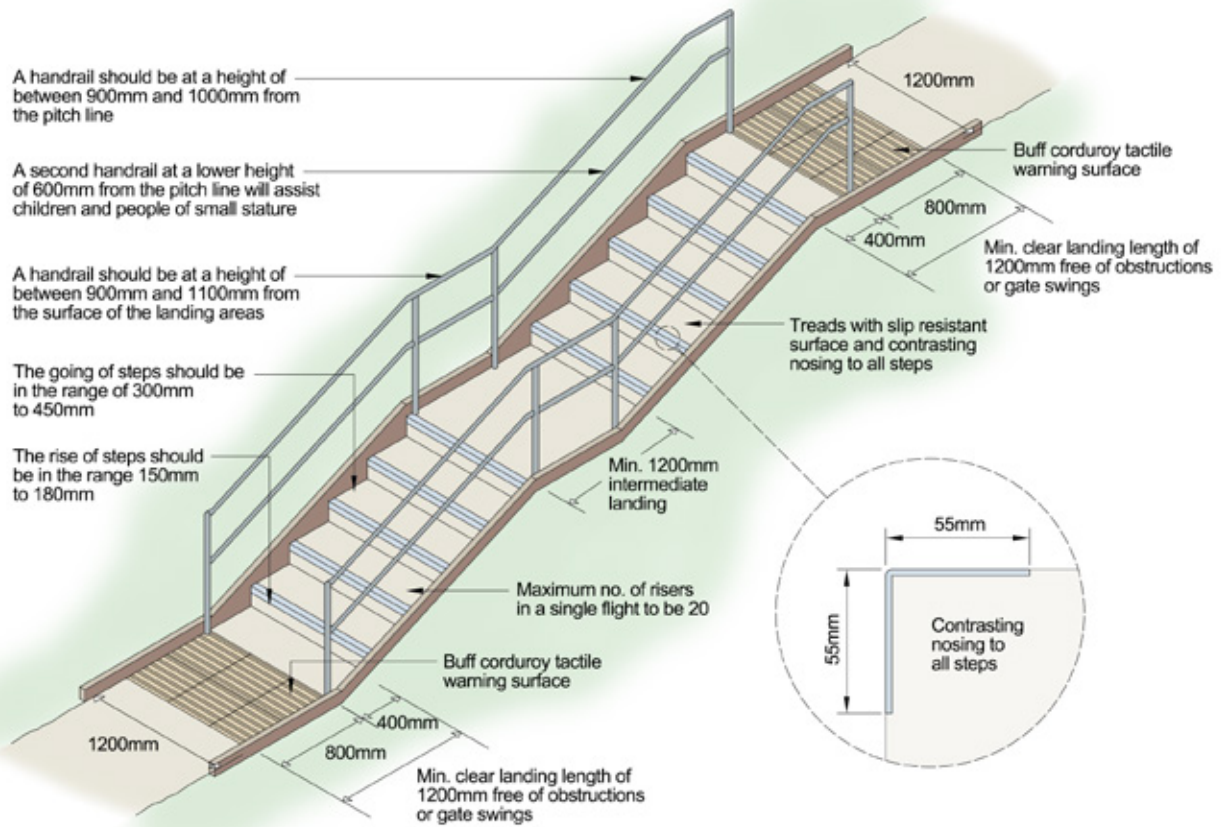

Figure 11 - External Steps

Recommended Standards

- Where a change in level less than 300mm is unavoidable or steps are unavoidable, they should be designed with complementary means of access within close proximity e.g. sloped by-pass route or ramp.
- Steps should be positioned away from the direct line of travel on an external route.
- The maximum number of risers in a flight should be twenty.
- A landing should be provided at the bottom and top of each flight of steps and intermittently where the number of risers required exceeds twenty.
- Flights of less than three risers should be avoided.
- Do not use single steps or tapered risers.
- There should be clear unobstructed step width of at least 1200mm and width between handrails should be not less than 1000mm.
- Where the width between handrails exceeds 2000mm, external steps should be divided into two or more, with width between handrails not less than 1000mm, or not more than 2000mm.
- There should be a minimum 30 degrees change in the direction between flights of steps if there are more than thirty-six risers in consecutive flights.
- Landing width should be no less than the flight width.
- The unobstructed landing length of each landing should be not less than 1200mm, clear of any gate swing.
- The rise of steps should be in the range 150mm to 180mm.
- The going of steps should be in the range of 300mm to 450mm.
- Step risers within a flight or series of flights should be uniform, as irregular risers can be confusing for people who are blind or partially sighted.
- Steps should be clearly visible and detectable by all users, including people who are blind or partially sighted.
- Step flights should incorporate drainage measures to prevent standing water and mud on step treads. **Note:** crossfall maximum 1 in 50.
- Where possible on frequently used steps and for safety on steps, provide weather protection from wind and rain in the form of a canopy or overhang.
- Provide solid, non-transparent closed risers (open risers are hazardous for people using canes, crutches and callipers).
- On sites where steps adjoin a slope, the interface between the slope and the steps should not form part of an external route and the interface point should be clearly distinguishable e.g. using visual contrast.
- A step should not overlap the step below. If an overlap is unavoidable, the nosing should not project by more than 25mm.

- In external environments where stepped amphitheatre-style seating in excess of three tiers is used, steps designed in accordance with standards should be provided to give access to the seats. See BS 8300-2:2018 Paragraph 17.4 for guidance principles.
- Surface finish should be slip resistant.
- Surface material on tread and risers should be non-patterned.
- Ground surface materials at landings should contrast with steps (maintain visual contrast on top and bottom step nosings).
- Corduroy tactile warning surface should be provided at the top and bottom of steps.

1.5.1 Step nosings

Recommended Standards

Step nosings should:

- Be distinguishable from the remainder of the step e.g. through suitable permanent visual contrast.
- Be durable for use in the external environment and regularly maintained.
- Extend the full width of the flight and be made of slip resistant material.
- Wrap around the step (preferably 55mm both on the tread and 55mm on the riser).



Guidance Signpost

- ▶ BS 8300-1: 2018. **Paragraph 9.1-9.1.7** Steps and Stairs, p.35-38.

1.6 Handrails

Overview

All users, including people with a range of disabilities will benefit from the provision of handrails to ascend and descend steps and ramps and to use boardwalks, bridges and platforms e.g. people who are blind or partially sighted and people with hidden disabilities such as epilepsy and heart conditions.

Recommended Standards

Handrails should:

- Be provided on each side of steps, ramps, boardwalks and bridges, and on platforms.
- Be used on lengthy slopes to offer support.
- Be at a height of between 900mm and 1000mm from the pitch line and between 900mm and 1100mm from the surface of the landing.
- Extend minimum 300mm horizontally beyond the top and bottom landings of a step flight or ramp (450mm preferred) and should be terminated in a way that will reduce the risk of clothing being caught.
- Be oval or circular in shape to offer good, comfortable grip:
 - A circular handrail should have a diameter in the range 32mm to 50mm.
 - An oval handrail should have dimensions of 50mm wide and 39mm deep with a radius of at least 15mm.
- Meet the handrail, centrally, on its underside.
- Be clearly distinguishable from safety barriers/guardrails using visual contrast e.g. when used along an external route for guiding or on an exposed edge.
- Not be cold to the touch and should have no sharp edges.
- Not project above the line of the continuous rail e.g. vertical uprights and there should be minimum 50mm clearance between the bottom of the handrail and any cranked fixing, to enable continuous grip without obstruction.
- Be impact resistant, securely anchored and with structurally sound fixing systems, including to the ground substrate, and capable of taking adequate loadbearing capacity and withstand impact without compromising the integrity of the rail e.g. from mobility scooters. Discuss suitable fixings with a specialist supplier.
- Not be uncomfortable to touch in settings subject to extremes of hot or cold.

- The surface of handrails should be distinguishable from the background against which they are seen e.g. through suitable visual contrast.
Note: the extent of visual contrast may be more variable within the external environment due to changing light and weather conditions, however this principle should be applied to accommodate.
- A second handrail at a lower height 600mm above ground level will assist children and people of small stature.
- Handrails are required in addition to safety guardrails, therefore provision of both may be required on some external steps.
- If steps consist of more than two flights connected by a landing the handrail should run continuously across the landing area.
- There should be a clearance of between 50mm and 75mm between a handrail and any adjacent wall or obstacle.
- Handrails comprising metals e.g. stainless steel, may become uncomfortable due to cold temperatures or wet and may be more suited to settings where anti-vandalism and low maintenance are key. Nylon or plastic coating could be applied to metal handrails to make them more comfortable.
- Non-splintering timber may be a suitable option in some settings.
- If required for safety purposes, guardrails should be designed to offer uninterrupted views.
- If glass panels are used on handrails or guarding, permanent safety markings which contrast visually with the background should be applied to assist people who are partially sighted.



Guidance Signpost

- ▶ BS 8300-2:2018. **Paragraph 9.3** Handrails to ramped and stepped access provision, p.42-44.

1.7 Accessible External Routes - Paths, Trails and Greenways: Guidance Chart



Mountain Trike ramble across open countryside routes (Image courtesy of Mountain Trike)

Overview

As external routes can be found in a vast array of settings and terrain, disabled people understand that the accessibility of routes will vary significantly because of their location, landscape and topography.

Although disabled people will understand that some routes in the most difficult terrain may not be accessible to everyone, where possible they want to experience outdoor places including open or wild countryside in the same way as non-disabled people. Designers and managers therefore should work to make external routes as accessible as possible. **Note:** as a core principle of sustainability, a balance should be sought between accessibility and the landscape setting (the former should not be at the expense of the latter). Making improvements to enhance access for people with disabilities should not be considered more detrimental than public access generally.

The **Recommended Standards** within Section 1.2 – 1.6 of this guide are provided to ensure best practice in the design of external routes and are considered essential in urban/urban fringe, formal and managed settings, such as public parks, forest parks and along greenways.

However, it is also expected that they will be adopted in all settings where it is feasible to do so; whether that be across rural, farmland and forest landscapes, or open and wild countryside. Table 1 has been developed to advise designers and managers of minimum accessibility standards for external routes in different types of terrain.



Ramble through woodland (Image courtesy of Mountain Trike)



Non-challenging external routes in terms of gradient, width and firm surfacing



An example of more challenging, steeper terrain which can become manageable for disabled people through the use of off-road mobility vehicles

Accessible External Routes - Paths, Trails and Greenways: Guidance Chart			
Feature	Easy Terrain Route	Moderate Terrain Route	Difficult Terrain Route
	<p>This generally relates to access for all or most; and the urban/urban fringe/formal/managed zone, incl public and forest parks and greenways setting. It also aligns with WalkNI Accessible Walks Grade 1.</p>	<p>This generally relates to access for many; and the rural/farmland/forest setting.</p>	<p>This generally relates to access for some; and the open and wild countryside setting.</p>
Route Width	<p>In accordance with Section 1.2.3 of this guide: External route width, therefore passing places are not required.</p> <p>Any occasional narrowing on routes, other than on greenways, should reduce the route width to minimum 1200mm for no more than 2000mm along the route.</p>	<p>Minimum 1200mm wide, with passing places 25-50m apart (2000mm by 2000mm in size).</p> <p>Any restrictions should reduce the width to minimum 915mm for no more than 300mm along the route and 1000mm for no more than 1600mm along the route.</p>	<p>Narrower than 1200mm (this should be no less than 1000mm).</p> <p>Any restrictions should reduce the width to minimum 815mm for no more than 300mm along the route and 915mm for no more than 1600mm along the route.</p> <p>Passing places are minimum 50m apart.</p>
Gradient	<p>Maximum 1 in 21 i.e. level or gently sloping, with suitable level landing areas where gradient is between 1 in 60 and 1 in 21.</p>	<p>Generally, level or gently sloping, however any gradient steeper than 1 in 21 has been designed in full accordance with ramp standards and whereby suitable gradient is related to length e.g. there will be no gradient steeper than 1 in 12 over a distance of 2000mm i.e. only acceptable in exceptional circumstances when no other options are available over a short distance. See Section 1.4 of this guide: Sloped Gradients and External Ramps on External Routes.</p>	<p>Some gradients are steeper than 1 in 15 (maximum permissible is 1 in 10 in open or wild countryside over short distances).</p>

Crossfall	Maximum 1 in 50.	Maximum 1 in 40.	Maximum 1 in 35 (1 in 25 permissible in open or wild countryside).
Ground Surface	Firm in all weathers, with no loose material over 5mm in diameter.	Firm with no loose material over 10mm in diameter.	Some, or all, ground surfaces along the route comprise loose material maximum 100mm in diameter or have characteristics that do not render them firm and hard in all weathers, which may be problematic when walking or wheeling. Localised obstacles such as tree roots, potholes or rutting up to 100mm in size for no more than 10m along the route.
Surface Joints/ Gaps	Maximum 5mm.	Maximum 5mm.	Maximum 12mm.
Barriers or Obstacles	No barriers or obstacles along the entire route.	There may be some barriers along the route, however these have been designed to offer least restrictive access and obstacles are by-passed.	There are some barriers along the route, however these have been designed to offer least restrictive access.
Resting Places	25-50m apart.	Maximum 100m apart.	100-300m apart.
Clear Headroom	Depends on anticipated users/activity. See Section 1.2.4 of this guide: Clear headroom.	Depends on anticipated users/activity. See Section 1.2.4 of this guide: Clear headroom.	Depends on anticipated users/activity. See Section 1.2.4 of this guide: Clear headroom.
Steps	No steps.	No single steps.	No single steps.
Route Definition	Clearly defined.	Clearly defined.	The route may be undefined.
Route Design	There are short, looped routes, or longer linear routes offer easy return options for people who may tire or become disorientated easily.	There are short, looped routes and longer linear routes.	The route may be lengthy.

Notes:

1. It is accepted that some external routes which fall outside the criteria above will prove incredibly challenging, or inaccessible for disabled people. For example, where:

- There may not be a defined route and single-file footfall only may be possible.
- Ground surfaces may be unstable or difficult to negotiate in all weathers.
- Some, or all, barrier gates along the route are not designed with accessible features.
- Gradients are steeper than 1 in 12 and crossfalls may be steeper than 1 in 35.
- Passing places and resting places are unavailable.

This generally aligns with WalkNI Accessible Walks Grade 5.

2. In all instances a clear wayfinding strategy should be adopted throughout the route.

Table 1 - Accessible External Routes - Paths, Trails and Greenways: Guidance Chart



Guidance Signpost

- ▶ WalkNI. Accessible Walks: <https://walkni.com/useful-info>
- ▶ Principles and Standards for Trail Development in Northern Ireland. Outdoor Recreation NI: <https://www.outdoorrecreationni.com/publication/guidance/trail-design/principles-and-standards-for-trail-development-in-northern-ireland/>
- ▶ British Standards Institute. BS 8300-1:2018. Design of an accessible and inclusive built environment. Part 1: External environment. Code of practice. 2018.
- ▶ Accessibility standards. Setting standards for countryside paths and trails. A good practice guide to disabled people's access to the countryside. Countryside for All Fieldfare Trust Ltd. Updated 2005.
- ▶ By All Reasonable Means. Least restrictive access to the outdoors. A guide produced by the Sensory Trust in collaboration with, and on behalf of, Natural Resources Wales. December 2017.
- ▶ Visitor Safety in the Countryside Group (guiding principles risk control matrix): <https://vscg.org>
- ▶ Derry City & Strabane District Council Green Infrastructure Plan 2019-2032.
- ▶ Sport Ireland Outdoors, National Trails Office. Management Standards for Recreational Trails and Classification and Grading of Recreational Trails.
- ▶ Sustrans traffic-free routes and greenways design guide. November 2019: <https://www.sustrans.org.uk/for-professionals/infrastructure/sustrans-traffic-free-routes-and-greenways-design-guide/>

1.8 Inclusive All-Terrain Vehicle Trails



Quadrix battery powered all-terrain vehicles in use at the All Out Trekking Project, Gosford Forest Park, County Armagh

Overview

A range of inclusive all-terrain vehicles are now available which allow disabled people to access and explore outdoor trails which were previously inaccessible to them. This has led to a small number of innovative projects and initiatives designed to give disabled people the opportunity to explore mountain bike trails and walking trails through the provision of pools of inclusive all-terrain vehicles. A successful example of this in Northern Ireland is the All Out Trekking Project in Gosford Forest Park, County Armagh where a range of electric battery powered all-terrain vehicles are used to enable disabled people to successfully access the forest's extensive range of walking and mountain bike trails.

The implementation of the design guidance below will support the development of inclusive mountain bike trails and walking trails which can facilitate the increased use of inclusive all-terrain vehicles and projects.

1.8.1 Adapting mountain bike trails for inclusive all-terrain vehicles

Recommended Standards

- Initially Green and Blue trails should be selected to be adapted for the use of inclusive all-terrain vehicle.
- The width of inclusive all-terrain vehicles varies but trail width must be 200mm wider than the widest part of the inclusive all-terrain vehicles being used (100mm either side).
- Entrance/exit and rock gates should have approximately 100mm clearance either side of the vehicle to allow space for error when passing through the gates.
- Trail features and natural obstacles such as rocks and roots must not be higher than the ground clearance dimensions of the vehicles.
- All four wheels should be on the trail surface for duration of the section. Corners should therefore be at a degree of sharpness that considers vehicle width, length and turning circle.
- Corners should be banked or flat to afford vehicle grip in corners.
- Where corner sections on the trail have an outside edge lower than the inside edge (i.e. an “off-camber”), the fall away should not be so steep that it reduces grip and safe passage of the all-terrain vehicle.
- Trail features (jumps, step downs, step ups) should have an alternative accessible line.
- Sections of the trail should have certain “run off areas” for pulling over to allow faster trail users to pass.
- Trails gradients should be assessed to ensure that specific inclusive all-terrain vehicles can be used safely.



Adequate space at rock gates is essential on all-terrain vehicle trails



Trail features and natural obstacles such as rocks and roots should not be higher than the ground clearance dimensions of the vehicles, as demonstrated here at Gosford Forest Park



Banked trail corner/holding berm with alternative accessible line around features



Wide all-terrain vehicle trails and trail challenge features, Gosford Forest Park

1.8.2 Adapting walking trails for inclusive all-terrain vehicles

Recommended Standards

- Shared-use paths/trails should be used.
- Trail width should be minimum 2000mm to allow safe passage of two-way traffic.
- Vehicles should be assessed and deemed fit for purpose on the trail surface.
- Steps and stiles should be avoided, but if unavoidable an accessible by-pass route should be available.
- Swing gates should be avoided, but if unavoidable they should be held open securely when all-terrain vehicles will be on the route.
- Staggered barriers should meet the Recommended Standards within Section 1.3.5 of this guide: Staggered barriers.
- Gradient should be assessed to keep both rider and equipment safe.
- Ideally, a looped route is best. If this is not possible, turning points should be incorporated to allow vehicles to turn and return safely.
- Always consider vehicle dimensions and turning circle of vehicles when designing new, or adapting existing, trails.



Section

2

Multi-sensory Greenspace and Outdoor Places Amenities

- 2.1 Multi-sensory Greenspace
- 2.2 Resting Places and Seating
- 2.3 Shelters and Picnic Tables
- 2.4 Accessible Bird Hides,
Viewing Areas and Platforms
- 2.5 Accessible Toilets,
Changing and Showering
- 2.6 Lighting in the External Environment
- 2.7 Assistance Dogs Toileting Facilities
- 2.8 RADAR Locks



Viewing screen/hide at Black
Devon Wetlands RSPB Reserve

2.1 Multi-sensory Greenspace



Natural timber sculptures, Claudy Country Park trail

Overview

An inclusive approach to the design of multi-sensory green space will enable disabled people to enjoy outdoor experiences. It is important to engage the six senses of Sight, Sound, Smell, Touch, Proprioception (awareness of where the body is in space) and Vestibular (balance and equilibrium).

Often formal sensory experiences are used to create a safe, enclosed space within the external environment e.g. a sensory garden or sensory loop trail, which some people find less overwhelming than a large open expanse. However, it is also important to design for the Kinaesthetic Sense i.e. design which offers the freedom for people to move, and to do so safely, through a range of sensory habitats beyond formal sensory gardens e.g. using a structured route network complemented by clear wayfinding tools and sensory pockets. Multi-sensory experiences can be found in any greenspace, utilising the air and climate, the vegetation/trees, sounds, textures, smells, the topography etc. They are for everyone's enjoyment and should not simply be considered as benefitting people who are blind or people who have Dementia.

Outdoor places can present many challenges for people with Dementia and older people. Implementing the following recommendations will ensure multi-sensory green space is inclusive of their particular needs.

Recommended Standards

- Sensory gardens and sensory trails should be usable in all weather conditions by offering sun, shade, shelter and by providing suitable ground surfaces.
- If a trail uses natural terrain and ground surfaces these must be well-compacted.

- Accessible external routes within a sensory garden or trail should not have dead ends. A looped/circular route with clear lines of sight and flow of footfall from single entry and exit points supports easy wayfinding, reduces confusion, and is easier to follow.
- The path network should link all sensory elements (e.g. trail sculptures) with key features located at the start, finish and key points along the route.
- Avoid sensory clutter on a sensory trail i.e. design trails so that there is never more than one sensory experience at any given point.
- In areas where sensory features are likely to present a potential pinch point, create a clear circulation zone around them.
- Use information boards with large text and tactile pictograms to encourage learning along the way and to highlight particular features.
- Provide places of quiet and respite within busier external environments and consider natural landscape for this purpose e.g. trees and hedges to buffer noise and offer shelter.
- Avoid patterns and sudden changes in ground surface that create dark shadows and could be interpreted as holes or sudden drops.
- Avoid furniture or surface finishes which produce glare and discomfort for people with photosensitivity.
- Provide signs at key decision points to and from associated facilities, including toilets.
- Water features can create a focal point or sensory feature. Where water is included for hearing and touch, it needs to be accessible to benefit all users e.g. planting shrubs only partially around the feature creates additional sensory interest but ensures access.
- The extent of a water feature should be detectable e.g. through visual contrast and a perimeter strip that comprises a different ground surface and sound to the main ground surface.
- Do not include hidden/concealed water features as they could be hazardous for people who are blind or partially sighted.
- Integrate planting pockets and trees within sensory gardens and on trails, as a means of achieving natural aesthetic whilst also providing sensory experience.
- Provide planting reachable from standing or seated positions. See Figure 12 of this guide: Planting Bank and Figure 13 of this guide: Raised Beds (sand, water and planting).
- Raised planters should be located clear of the external route width, including along 'desire lines' i.e. the shortest or most easily navigated pedestrian route between an origin and a destination (BS 8300-1:2018).
- Sculptures should not obstruct or reduce external route width.

- Use trail markers which are different to general waymarkers to denote the direction and location of sculptures on a trail. Complement this with a sculpture trail map.
- If sections of a sculpture trail are on difficult terrain, this should be denoted on the trail map and clearly annotated.
- Circulation around the perimeter of sculptures should be minimum 1500mm wide (2000mm preferred).
- Projecting sculptures must not present a potential hazard at ground or eye level.
- Sculptures should be able to offer support or act as a leaning post, which assists people with reduced mobility.
- Rest areas should be provided for respite or quiet and to enable social interaction if desired. See Section 2.2 of this guide: Resting Places and Seating.
- Outdoor gyms can encourage all generations to be active. Where exercise and fitness equipment is provided, some apparatus should be included to accommodate the needs of older people, people with Dementia, wheelchair users and people who are partially sighted.

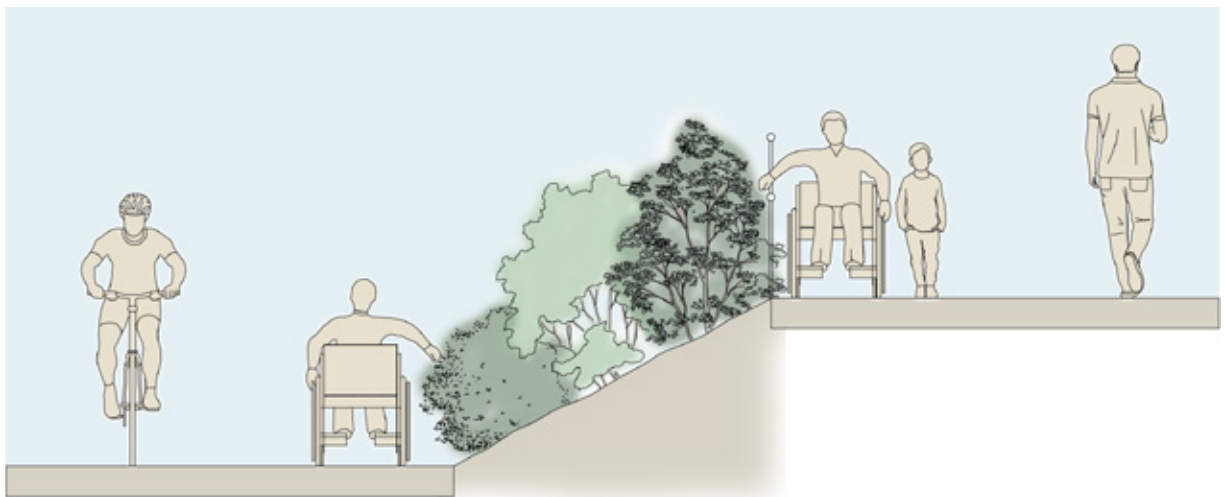

Figure 12 - Planting Bank

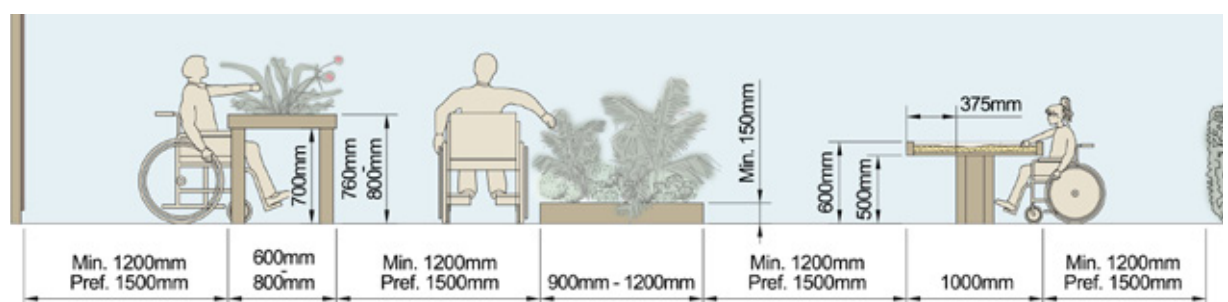

Figure 13 - Raised Beds (sand, water and planting)



Raised water table and tactile sculpture for touch and sound, role play and climbing (Images courtesy of Hand Made Places)



Sensory trail markers (Image courtesy of The Sensory Trust)



Tactile raised water feature positioned adjacent to external route, Claudy Country Park



Raised planters, accessible shelter/viewing area and reinforced grass (Image courtesy of The Wild Deck Company Ltd)



Outdoor Fitness Equipment, Buttermilk Walk Broughshane



Guidance Signpost

- ▶ Growing Older. Mobility and sensory perception in old age. Richter Spielgeräte GmbH. August 2018.
- ▶ Natural England March 2016 “Is it nice outside?” Natural England Commissioned Report NECR211: Wood if we could:
- ▶ <https://dementiaadventure.co.uk/wp-content/uploads/2018/03/Wood-if-we-Could.pdf>
- ▶ Alzheimer’s Society UK: <https://www.alzheimers.org.uk/dementia-professionals/resources-professionals/resources-gps/dementia-friendly-signage>. Neil Mapes and Tony Vale. March 2013.
- ▶ Sensory Gardens factsheet. The Sensory Trust.

2.2 Resting Places and Seating

Overview

The provision of resting places and seating along accessible external routes is essential to provide respite to older people, people with mobility difficulties, and people with other hidden disabilities. The location of resting places should be carefully considered to take account of factors like sun, shade, accessible external routes, wildlife viewing points and features of interest.

A variety of rest seating style and height is recommended to offer choice and to assist people with a wide range of abilities e.g. formal bench seating with and without armrests to assist older people and wheelchair users who wish to transfer; lower seats for children and people of small stature; higher seats and perch seats. The creative use of natural features such as walls, rocks, fallen trees and logs can also serve as informal rest seating options.



Resting place with seating on firm hardstand, offset from main external route and at the top of steps, Claudy Country Park

2.2.1 Resting places

Recommended Standards

- Provide a resting place every 25-50m on external routes, on steep slopes and at lengthy step flights. **Note:** in certain settings it may be acceptable to locate resting places at greater intervals apart.
- Resting places should be adjacent to, but clear of external route width and should not be accessed only by external steps.
- Resting places should comprise a firm, level ground surface flush with the main external route.
- At all times resting places should have space on both sides to enable a wheelchair user or assistance dog to rest alongside clear of the main external route.
- Locating resting places within a shelter and/or where there is a feature of interest where possible (e.g. close to bird habitats and wildlife viewing spots).
- A rest seat should be provided at resting places. See Section 2.2.2 of this guide: Seating.

2.2.2 Seating

Recommended Standards

- It is essential that some rest seating can be accessed directly from an accessible external route.
- Seats with and without arm and backrests are required to assist people when sitting down and standing up.
- Seats of varying heights in the range of 450-480mm should be provided where possible to assist a range of user needs.
- Seats 480mm high without armrests (or with armrests inset by 500-750mm from the edge) enable direct transfer from a wheelchair.
- Seats 350mm high will assist people of small stature and children.
- Seats 520-580mm high will assist older people and people with reduced upper body strength.
- Bench and perch seats should have flat profiles to assist ambulant disabled people and older people.
- Where bench seats have backrests, these should not be less than 300mm from seat level (700mm preferred).
- Armrests should be 200mm from seat level and extend from the back to cover minimum 80% of the seat depth.
- Where intermediate armrests are installed on a seat, space between armrests should be minimum 500mm.
- Perches seats should be 500-750mm high and 650-800mm high, with a slightly angled surface.
- Seats should contrast visually with the background against which they are seen and armrests should contrast against the seat.
- Seats should not have a highly reflective finish. Choose a finish material with thermal properties, which will be comfortable to sit on even when it is cold e.g. timber.
- Seats should be located on a firm, level ground surface flush with the main external route.
- Large logs and low walls can often serve as informal resting/seat spots if carefully designed.
- On sites where amphitheatre-style seating is provided to facilitate outdoor play events or performances, provide clear signs and tactile cues to give advanced warning and include measures to protect against falling e.g. guard railing to offer protection on the top tier.
- See Figure 14 of this guide: Features of an Accessible External Route.

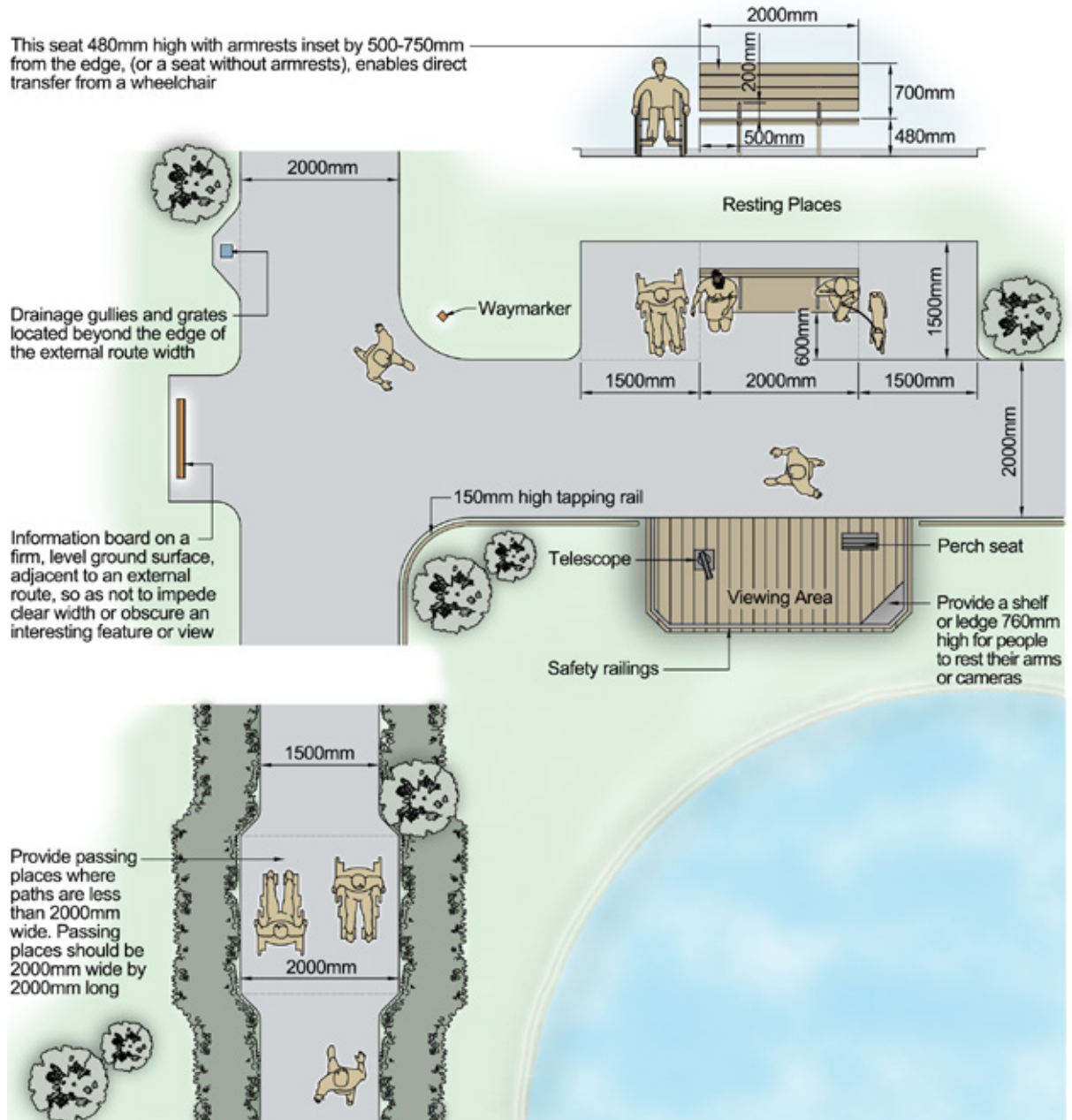

Figure 14 - Features of an Accessible External Route



Rest bench on SEEK natural trail, RSPB Portmore Lough Nature Reserve (Image courtesy of RSPB)



Resting place with bench offset from main external route, Victoria Park Belfast



Rest benches on dipping pond platform (Image courtesy of The Wild Deck Company Ltd)

2.3 Shelters and Picnic Tables



Accessible viewing shelter/hide with sloped access and clear turning area (Image courtesy of The Wild Deck Company Ltd)

Overview

Where shelters and picnic tables are provided in outdoor places they should be designed to be inclusive of disabled people. Shelters are normally manmade structures but on external routes and in parks, natural features such as trees or an outcrop can also provide areas of shelter.

Recommended Standards

- Locate shelters and picnic tables where they are needed and will be fully utilised e.g. at setting-down points, adjacent to toilets, at resting places and information board locations.
- Shelters and picnic tables should be accessible directly from an external route.
- Shelters should contain rest seating options and clear turning space for wheelchair users and off-road mobility scooters.
- Divert water run-off away from the entrance and front of a shelters and provide drainage to avoid puddling or muddy conditions on external routes.
- Where picnic tables are provided generally, some picnic tables should be designed to be accessible. One, or more, wheelchair users should be accommodated at accessible picnic tables. See Figure 15 of this guide: Accessible Picnic Tables.
- If sites are open in the evening or at night, good lighting should be provided where feasible.
- Providing a range of accessible picnic tables is preferable.



Examples of accessible picnic tables - circular table with integrated wheelchair space and rectangular table with extended cantilever to enable wheelchair users to sit comfortably at the table end (Images courtesy of Gametime®)



Accessible picnic table, Diversity Park Portstewart

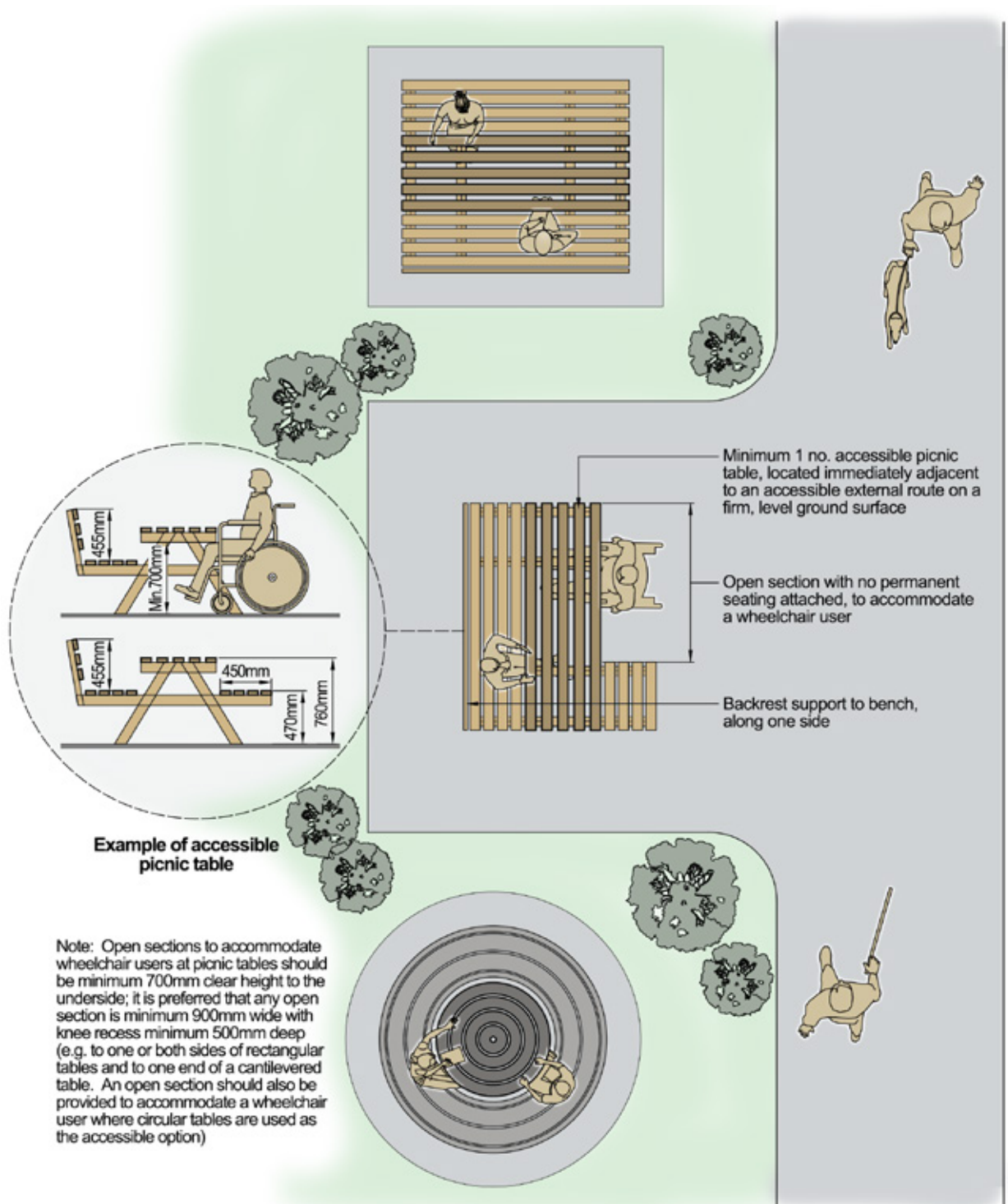

Figure 15 – Accessible Picnic Tables

2.4 Accessible Bird Hides, Viewing Areas and Platforms



Bird hide and boardwalk approach RSPB Portmore Lough Nature Reserve
(Image courtesy of RSPB)

Overview

Where bird hides, viewing areas and platforms are provided they should be designed to be accessible to all visitors including disabled people.

2.4.1 Bird hides

Some examples of accessible bird hides are illustrated below. An example accessible bird hide design is provided in Figure 16 of this guide: Accessible Bird Hides.



Viewing screen/hide at Black Devon Wetlands RSPB Reserve
(Image courtesy of David Palmar, Conservation Photographer: www.photoscot.co.uk)

This accessible viewing screen provides an alternative to the traditional bird hide. It enables discreet viewing as well as open wildlife observation/views on all sides. The accessible boardwalk approach, large clear turning space within, rest benches, protective railings on the exposed side and viewing slots at a range of heights whether seated or standing, provides inclusive viewing opportunities for everyone.

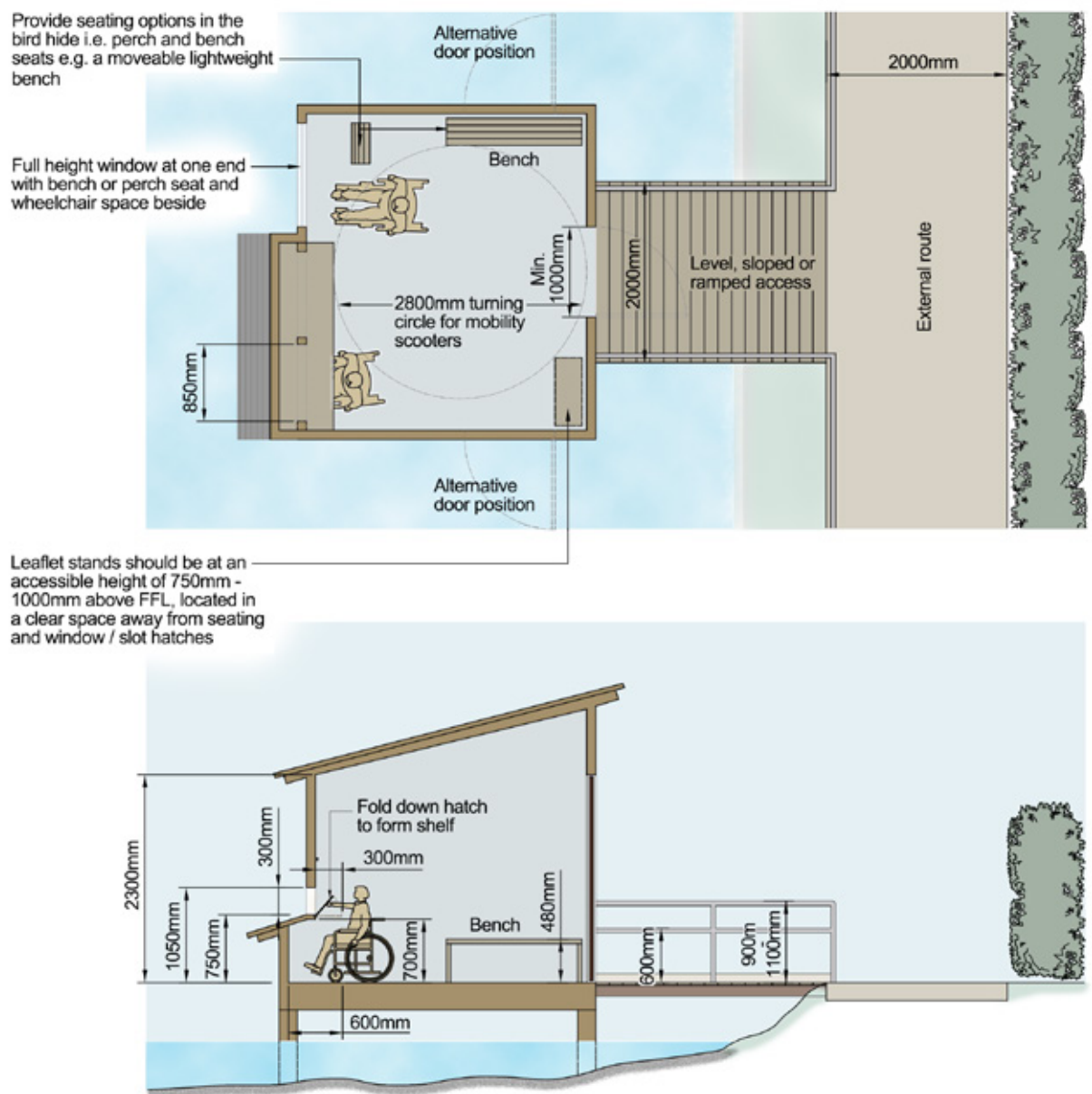

Figure 16 - Accessible Bird Hides



Accessible bird hide with ramped access and canopy
(Image courtesy of The Wild Deck Company Ltd)



Interior showing standard viewing hatches and lowered viewing hatch with clear knee space below, shelves and rest seating at Moyola Nature Reserve



Bird hide exterior showing lowered viewing hatch with knee space below, Moyola Nature Reserve



Full height glazing in bird hides enables viewing for all
(Image courtesy of The Wild Deck Company Ltd)

2.4.2 Viewing areas and platforms

Recommended Standards

- External routes leading to viewing areas should be accessible from the point of arrival e.g. parking area.
- Viewing areas should have a firm, level ground surface.
- Where possible, combine with resting places which include seating.
- Provide a shelf or ledge 760mm high for people to rest their arms or cameras.
- Where railings are provided for safety, balustrades should be 100-125mm apart and allow for a maximum 920mm viewing height e.g. infill panels which offer clear visibility in the range 800-920mm above ground level.
- Associated information panels at viewing areas should not obstruct views or the approach route.
- Where viewing platforms are provided they should be accessible of disabled people. An example of an accessible observation platform is provided in Figure 17 of this guide: Observation Platforms and Viewing Telescopes.



Accessible observation platform with rest seat
(Images courtesy of The Wild Deck Company Ltd)

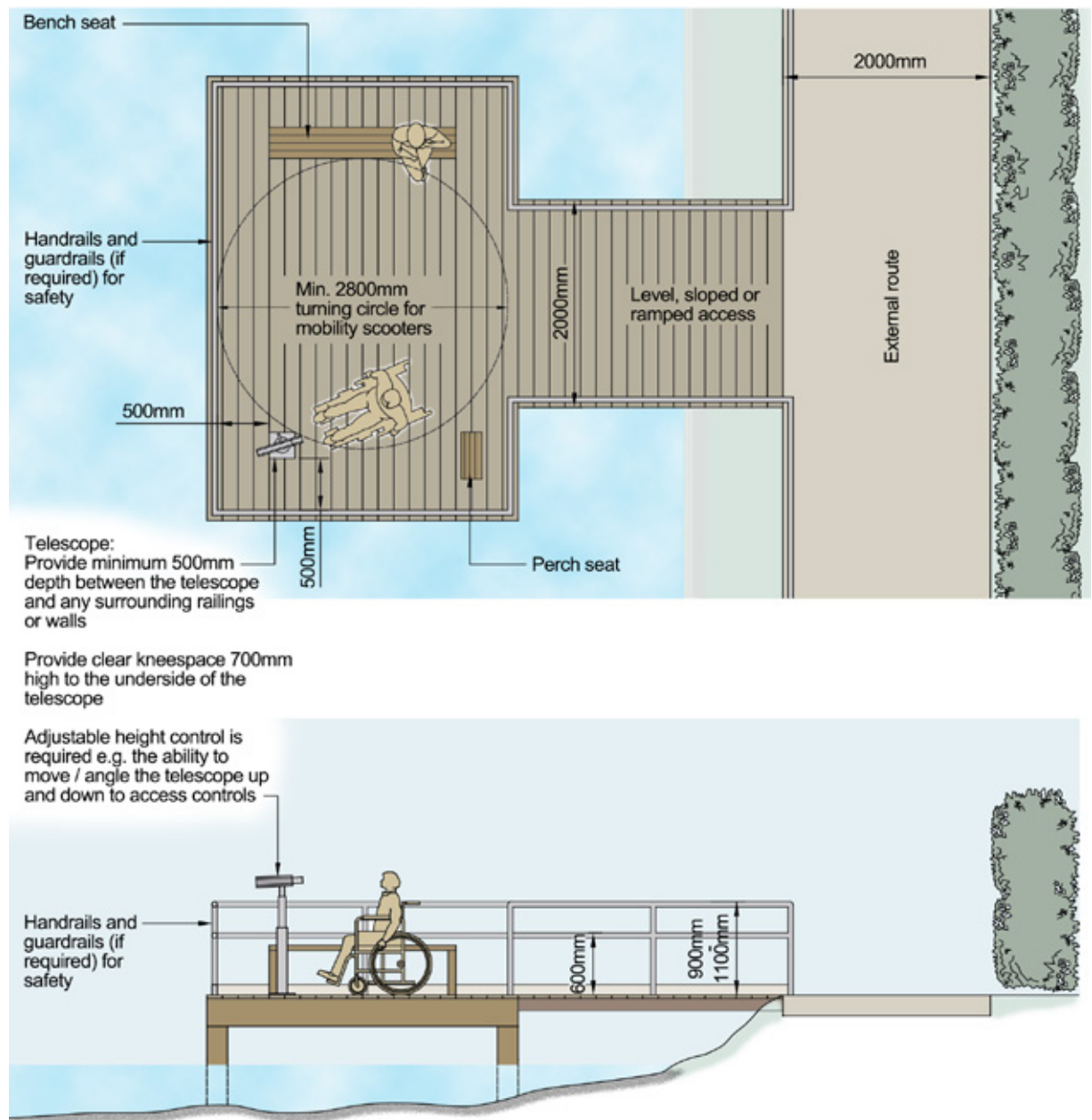

Figure 17 - Observation Platforms and Viewing Telescopes



Guidance Signpost

- Birding for All. Best Practice Guide. 2017. <https://birdingforall.com/wp-content/uploads/2017/02/birding-for-all-best-practice-2017.pdf>

2.5 Accessible Toilets, Changing and Showering



Accessible toilet facility including height adjustable adult sized changing bench and hoist (Image courtesy of Portakabin®)



Accessible toilet provision is essential in outdoor places (Image courtesy of Portakabin®)

Overview

The lack of good quality toilet, changing and showering facilities presents a significant barrier to the accessibility of outdoor places and the participation of disabled people in outdoor recreation. Public toilets, including accessible toilet facilities, should be provided to serve outdoor places and activities, whilst changing and showering facilities are also required to assist people participating in water-based activities.

Provision of Changing Places toilets will enable many more disabled people, including those with complex and multiple disabilities, to enjoy outdoor places and participate in outdoor activities with their families.

2.5.1 Design of toilet blocks in outdoor places

Overview

Wherever a general block of male/female toilets is provided to serve outdoor places they should be designed to be inclusive of non-disabled people and disabled people.

Recommended Standards

- A wheelchair accessible WC cubicle for independent use, with minimum dimensions 1700mm by 2200mm. See Figure 19 of this guide for fit-out: Unisex Wheelchair Accessible WC. **Note:** in relation to Technical Booklet R NI 2012, this unit will suffice as an 'enlarged WC compartment' where a male or female block contains four or more cubicles.
- An ambulant accessible toilet cubicle, with outward opening door swing in each male and female toilet block.
- At least one accessible urinal should be at a height suitable for wheelchair users in each male toilet block.
- At least one accessible wash hand basin should be at a height suitable for both ambulant disabled people and wheelchair users in each male and female toilet block.
- See Section 2.5.3 of this guide: Changing Places toilet facilities.

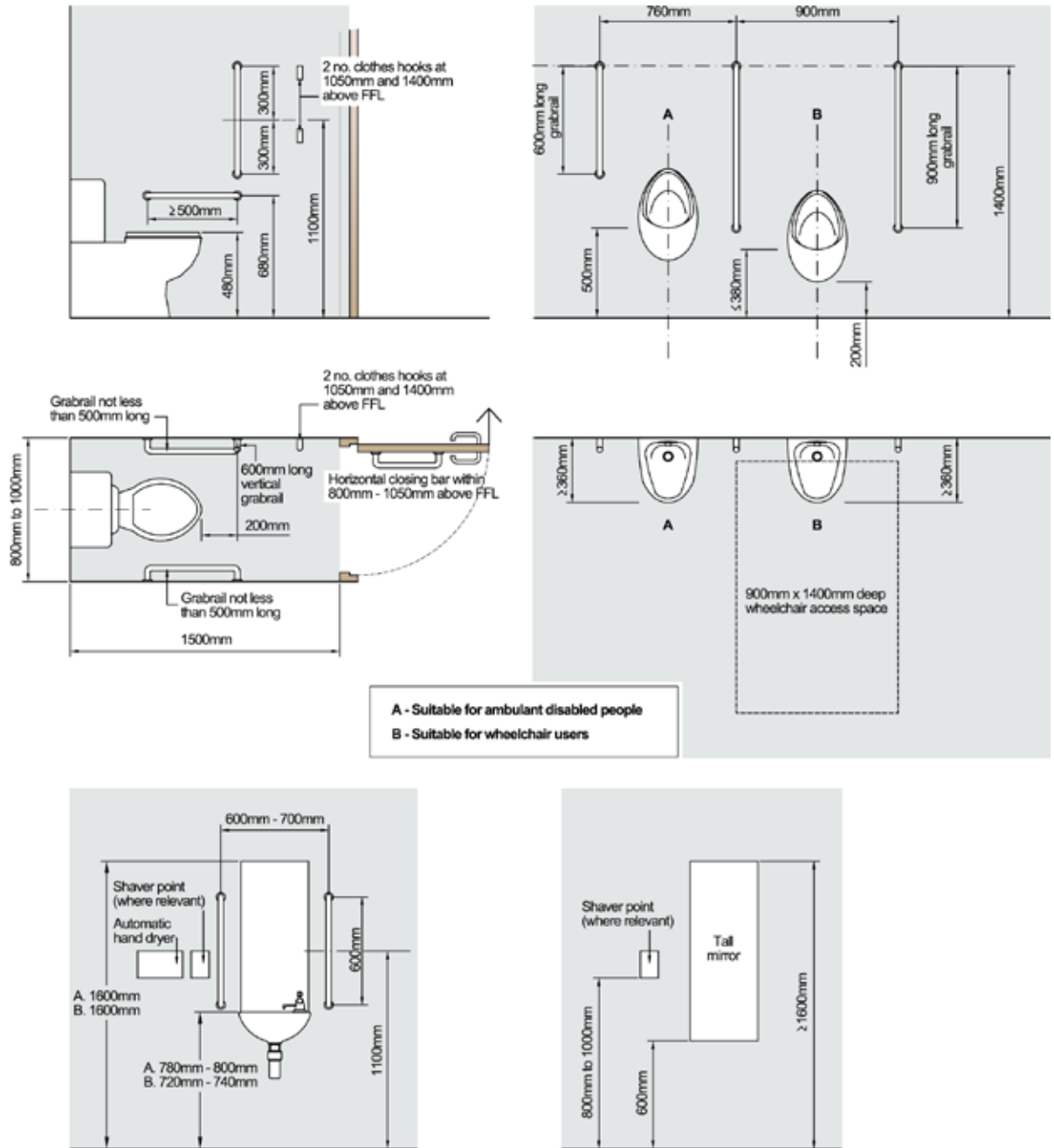

Figure 18 - Ambulant WC Cubicle, Urinals and Wash Hand Basins (accessible to wheelchair users and ambulant disabled people)

2.5.2 Self-contained Unisex Wheelchair Accessible WC



Standard and wheelchair accessible toilet provisions with level access, RSPB Portmore Lough Nature Reserve (Image courtesy of RSPB)

Overview

A Unisex Wheelchair Accessible WC should be provided in addition to male/female inclusive toilet blocks in outdoor places, or as an alternative where only limited combined male/female/accessible toilet provision is feasible.

Recommended Standards

- A self-contained wheelchair accessible corner layout WC for independent use, with minimum dimensions 1700mm by 2200mm. **Note:** if this is the only toilet to serve an outdoor place, the unit should also contain a standing height wash hand basin (overall unit dimensions minimum 2000mm by 2200mm).

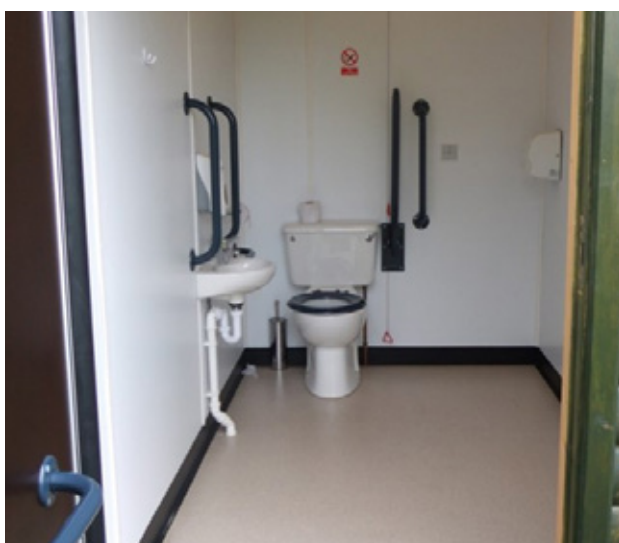

Accessible WC at RSPB Portmore Lough Nature Reserve (Image courtesy of RSPB)

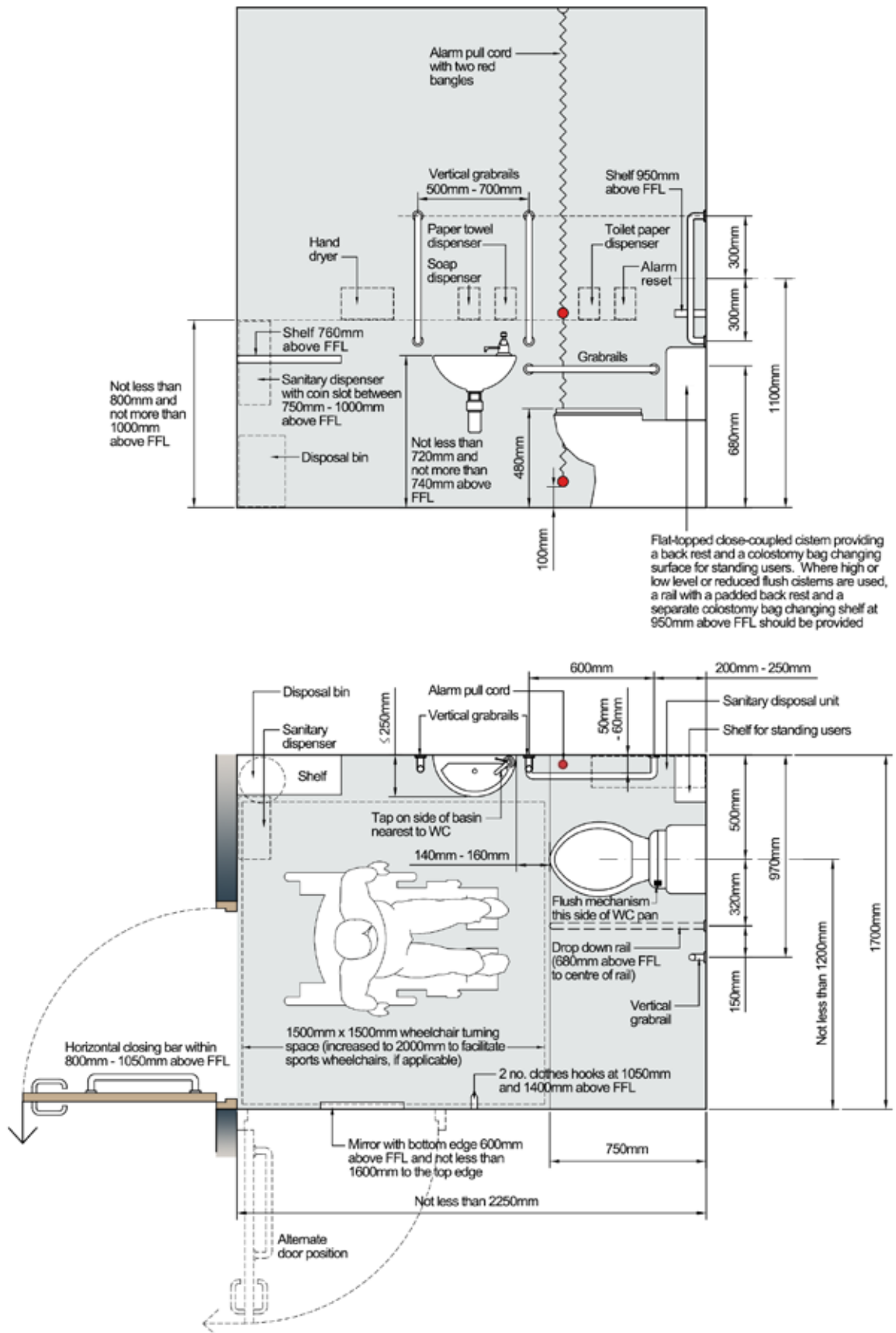
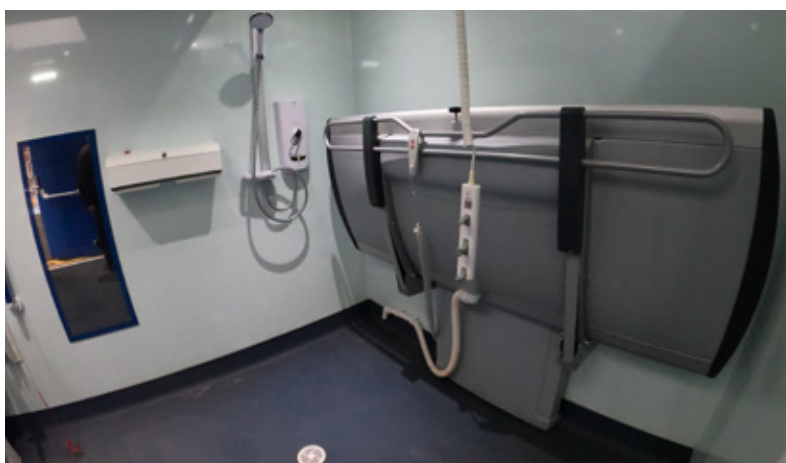

Figure 19 - Unisex Wheelchair Accessible WC

2.5.3 Changing Places toilet facilities



Registered Changing Places toilet facility at Canthed Surf Centre, Caswell Bay Swansea (Image courtesy of Surfability UK)



Wall-mounted adult sized changing bench and shower facility, Canthed Surf Centre Changing Places toilet (Image courtesy of Surfability UK)

Overview

A Changing Places toilet facility assists many more disabled people, including those with complex and multiple disabilities. A Changing Places toilet includes an adult sized changing bench and hoist, in addition to a shower and toilet. In outdoor places, provision should be made in the form of a permanent constructed building or permanent prefabricated modular unit (registered as a Changing Places toilet through Muscular Dystrophy UK); or a temporary modular unit for use during outdoor events.

Note: a permanent modular unit may be an appropriate solution in some outdoor settings such as parks and beaches, or where an existing building may lack floor space to make adaptations.

A key recommendation of Outdoor Recreation NI's report, Changing Places in the Outdoors states: "Changing Places in the Outdoors should be developed with early consultation (at concept stage) with the Changing Places Consortium, local Lived Experience organisations, and prospective end users, and with consideration for the physical and social surroundings in which the facility is planned."

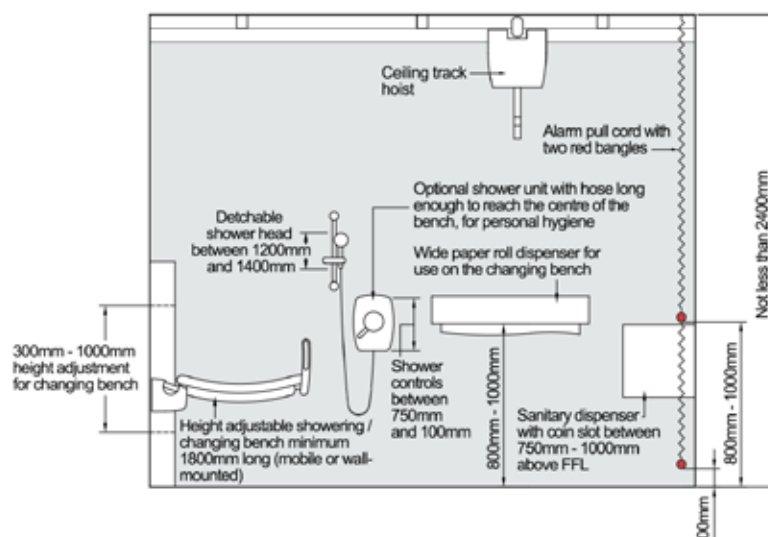
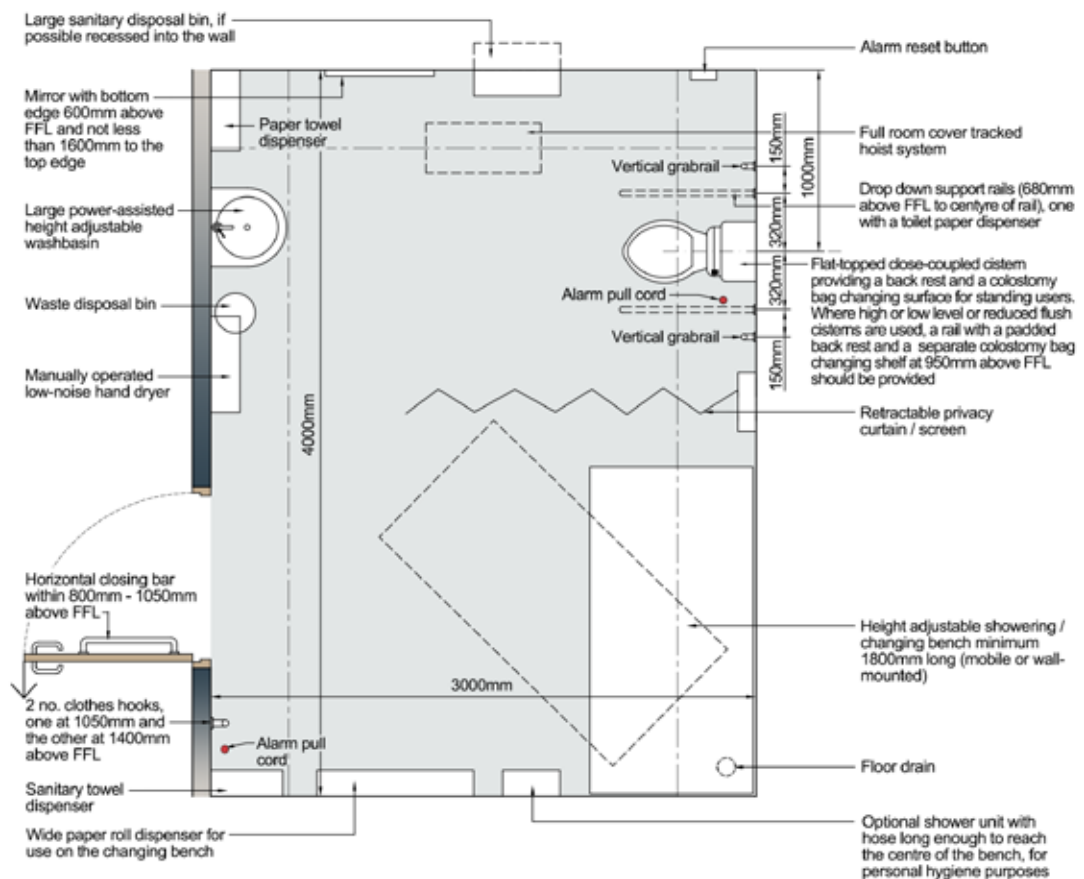

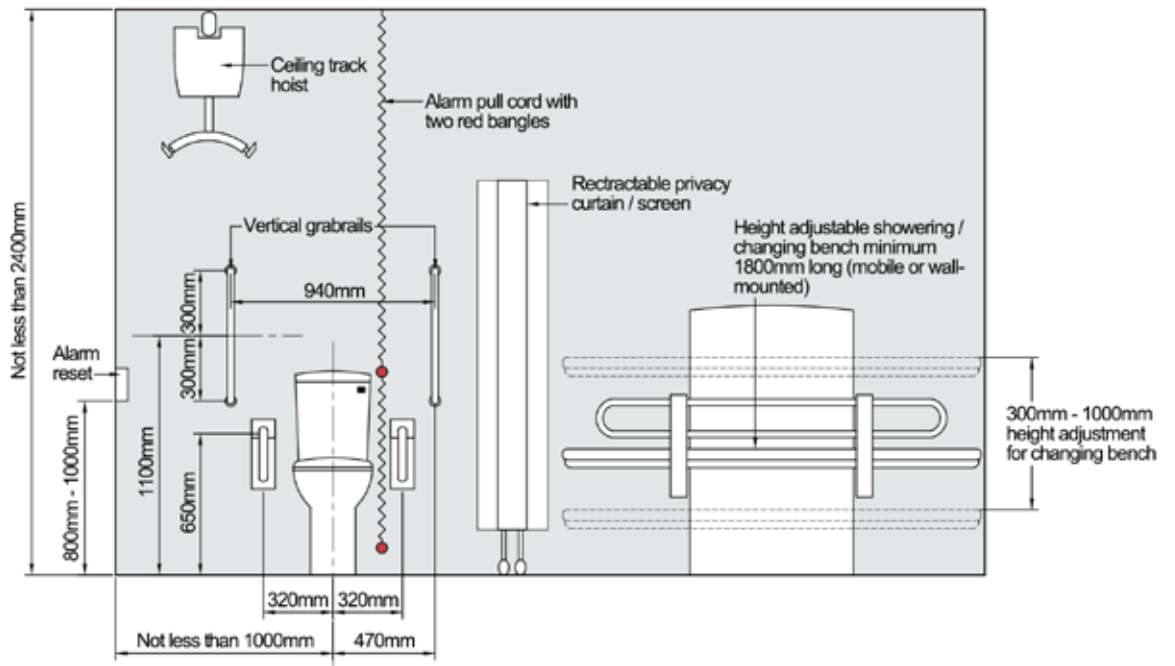
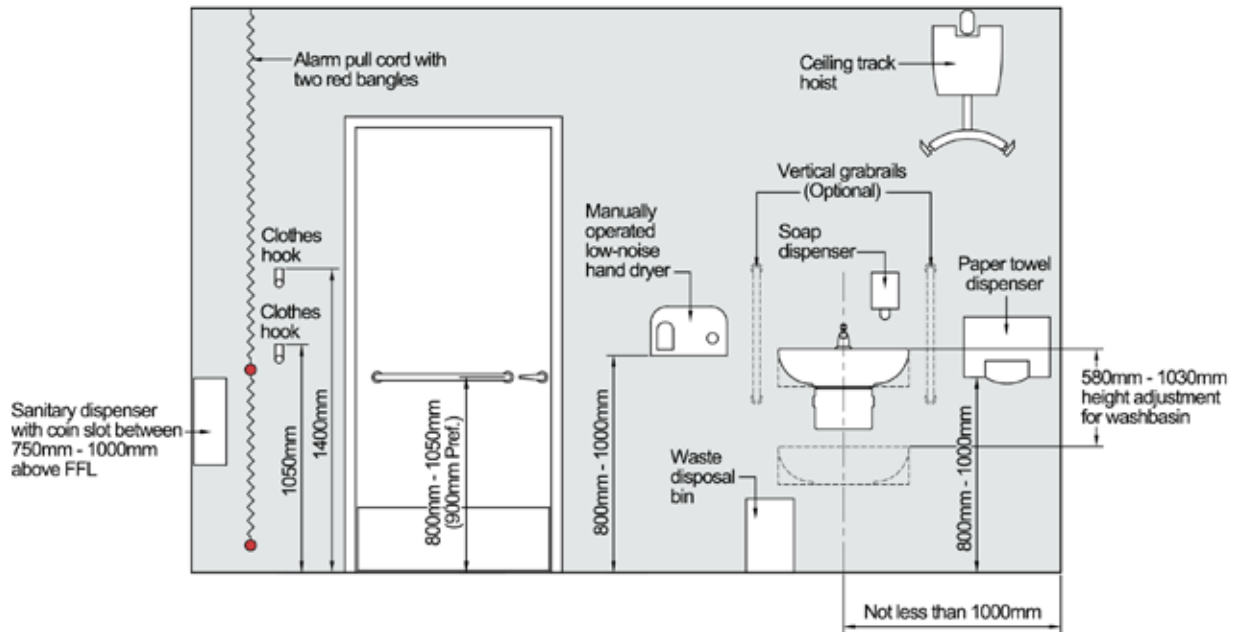

Figure 20 - Changing Places Toilet



Accessible toilet unit including height adjustable wash hand basin, height adjustable changing bench, shower and hoist (Images courtesy of Portakabin®)



Registered Changing Places toilet facility at Kirroughtree Galloway Forest Park, Scotland (Image courtesy of Changing Places/Muscular Dystrophy)



Guidance Signpost

- ▶ Changing Places Consortium: <https://www.changing-places.org>
- ▶ iHUS Group: <https://www.ihuschangingplaces.com/>
- ▶ Bailie Boro Supplies: <https://www.bailieborosupplies.ie>
- ▶ Portakabin®: <https://www.portakabin.com>

2.5.4 Baby changing



Accessible toilet unit with baby changing facility (Image courtesy of Portakabin®)

Overview

A parent or a child may have a disability.

Recommended Standards

- Baby and child changing should be accessible and, where location allows, should be separate to accessible toilet facilities.
- A child-sized bench instead of, or in addition to, a baby bench accommodates a broader range of need (preferably height adjustable).

2.5.5 Accessible changing and showering

Overview

To serve outdoor activities, changing and shower areas should be designed to be inclusive of non-disabled people and disabled people, to accommodate a range of abilities and provide a degree of choice. It may be that in certain locations where space is restricted, accessible changing and shower provisions will be used by all participants and staff e.g. on a marina dockside.

2.5.5.1 Inclusive changing area

Recommended Standards

- Where male/female changing blocks are provided, they should be designed to be inclusive of non-disabled and disabled people and have one wheelchair accessible incorporated changing provision. See Figure 21 of this guide: Inclusive Changing Area (with wheelchair accessible incorporated provisions).

- See Section 2.5.3 of this guide: Changing Places toilet facilities.

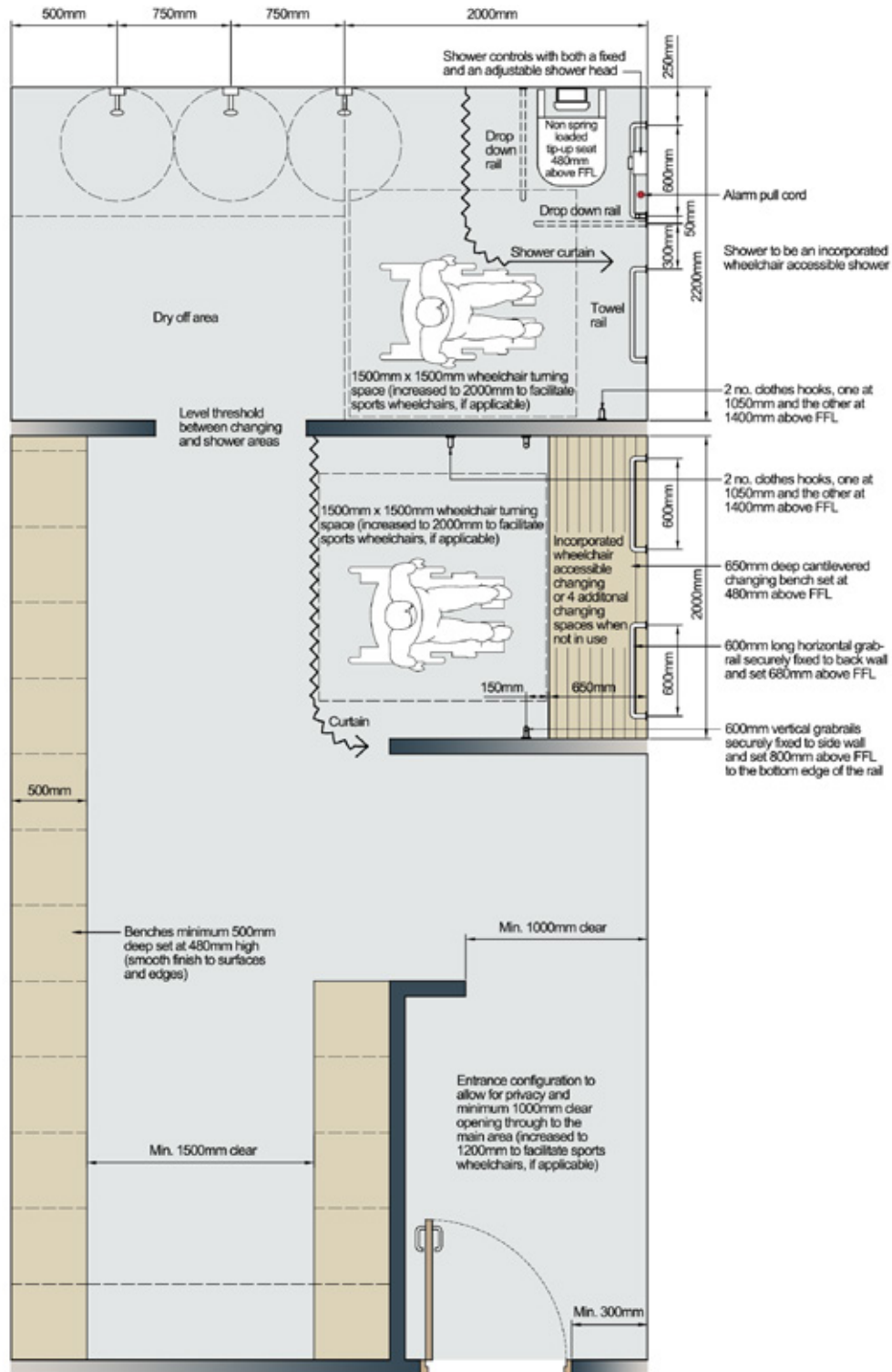

Figure 21 - Inclusive Changing Area (with wheelchair accessible incorporated provisions)

2.5.5.2 Shower provision



Shower buildings (Image courtesy of Portakabin®)

Recommended Standards

- Where male/female shower blocks are provided, they should be designed to be inclusive of non-disabled and disabled people and have one wheelchair accessible incorporated shower provision. See Figure 21 of this guide: Inclusive Changing Area (with wheelchair accessible incorporated provisions).

2.5.5.3 Self-contained unisex accessible changing/shower/WC unit



Accessible toilet/shower (Image courtesy of Portakabin®)

Overview

Self-contained unisex accessible changing/shower/WC units to serve outdoor activities are necessary to accommodate people who prefer more privacy, require more space or require the assistance of someone of the opposite gender.

Recommended Standards

- At least one self-contained unisex accessible changing/shower/WC unit. See Figure 22 of this guide: Self-contained Unisex Accessible Changing/Shower/WC Unit.

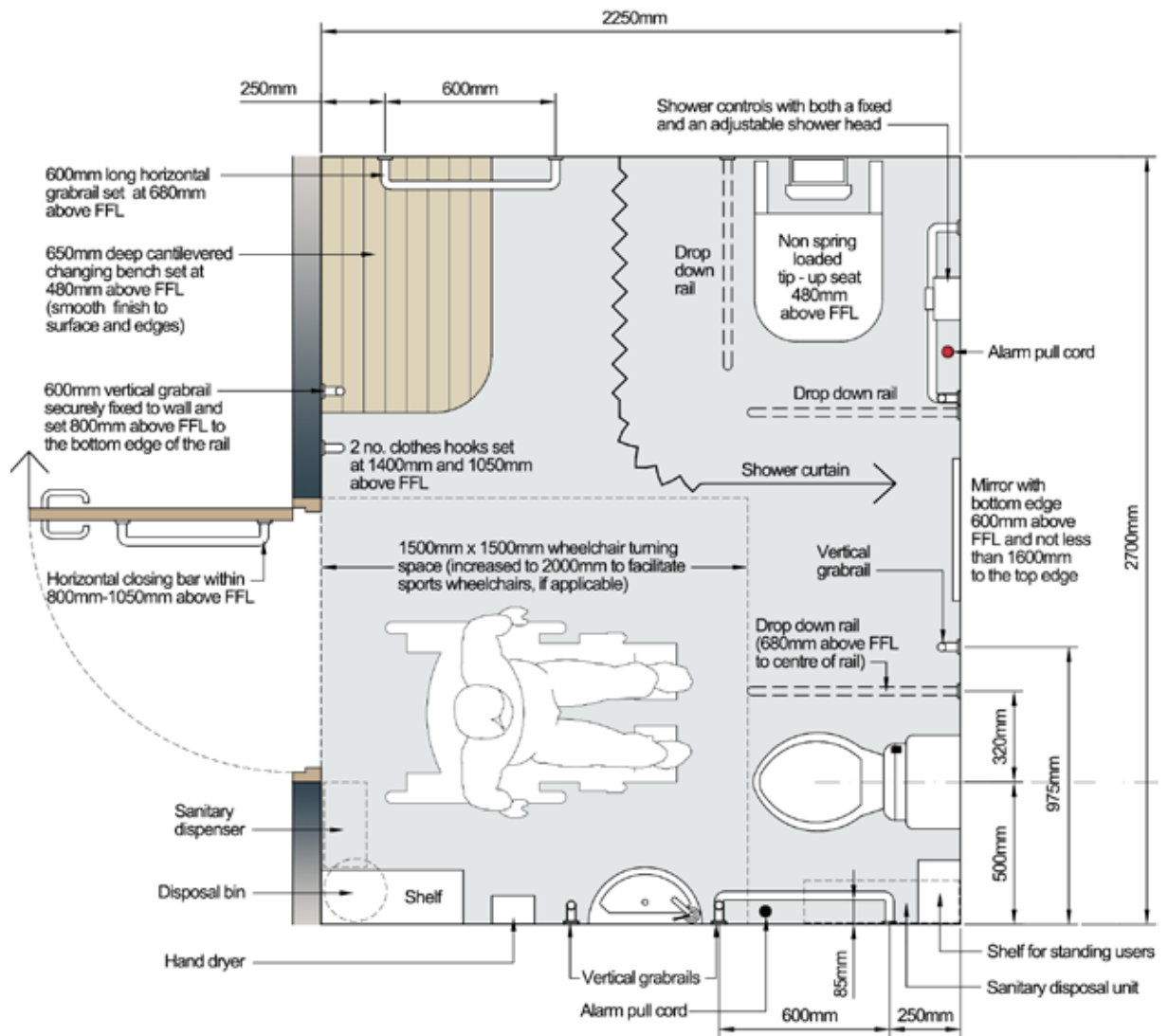

Figure 22 - Self-Contained Unisex Accessible Changing/Shower/WC Unit

2.5.5.4 Fit-out of changing and shower areas

Recommended Standards

- Floor finishes must be slip resistant.
- Suitable space should be provided to enable transfer from a wheelchair to a tip-up shower seat or bench.
- Tip-up shower seats should not be sprung. Vertical struts should not be incorporated in tip-up shower seat or bench design.
- Minimum 1500mm by 1500mm turning space should be available when the tip-up shower seat is in the down position.
- Shower controls should be lever operated and located at an accessible height in the range 750mm to 1000mm above floor level.
- There should be a height adjustable shower head in the range 1200mm to 1400mm above floor level and, in self-contained unisex accessible changing/shower/WC units, a fixed shower head also.

2.6 Lighting in the External Environment

Overview

High quality lighting is essential in the design of outdoor places which are inclusive, safe and comfortable.



Guidance Signpost

- ▶ BS 8300-1:2018. Table 5 The artificial lighting of specific applications, p.53.
- ▶ Inclusive Design Standards. London Legacy Development Committee. May 2019.

2.7 Assistance Dogs Toileting Facilities



Clear sign to denote Assistance Dogs facilities on-site

Overview

Whilst assistance dogs are commonly associated with a 'guide dog' for people who are blind or partially sighted, they can also assist individuals with other impairments e.g. 'hearing dogs' for people who are deaf or have hearing loss and 'service dogs' for people with physical disabilities. A dog toileting facility is a designated area where assistance dogs can relieve themselves. In certain settings, assistance dogs toileting facilities should be provided in outdoor places to enable people accompanied by an assistance dog to toilet their dog safely e.g. in urban/urban fringe, formal and managed parks, and play park settings.

Recommended Standards

- The dog toileting facility should be a secure enclosed area minimum 3000mm by 4000mm.
- It should preferably comprise 50% grass surface and 50% hard standing. **Note:** in certain settings, 100% hard standing may be acceptable, therefore consult with Guide Dogs NI on the use of alternative surface options on a site specific basis.
- A sign should be clearly displayed to denote 'Assistance Dogs Only'.
- Provide a crossfall gradient to assist drainage, maximum 1 in 50.
- The entrance gate should be minimum 1200mm wide and have an opening mechanism that is easy to locate, grip and operate.
- Secure boundary fencing offering good visibility should be installed, minimum 1200mm high.
- Provide a water supply, hose and a disposal bin.

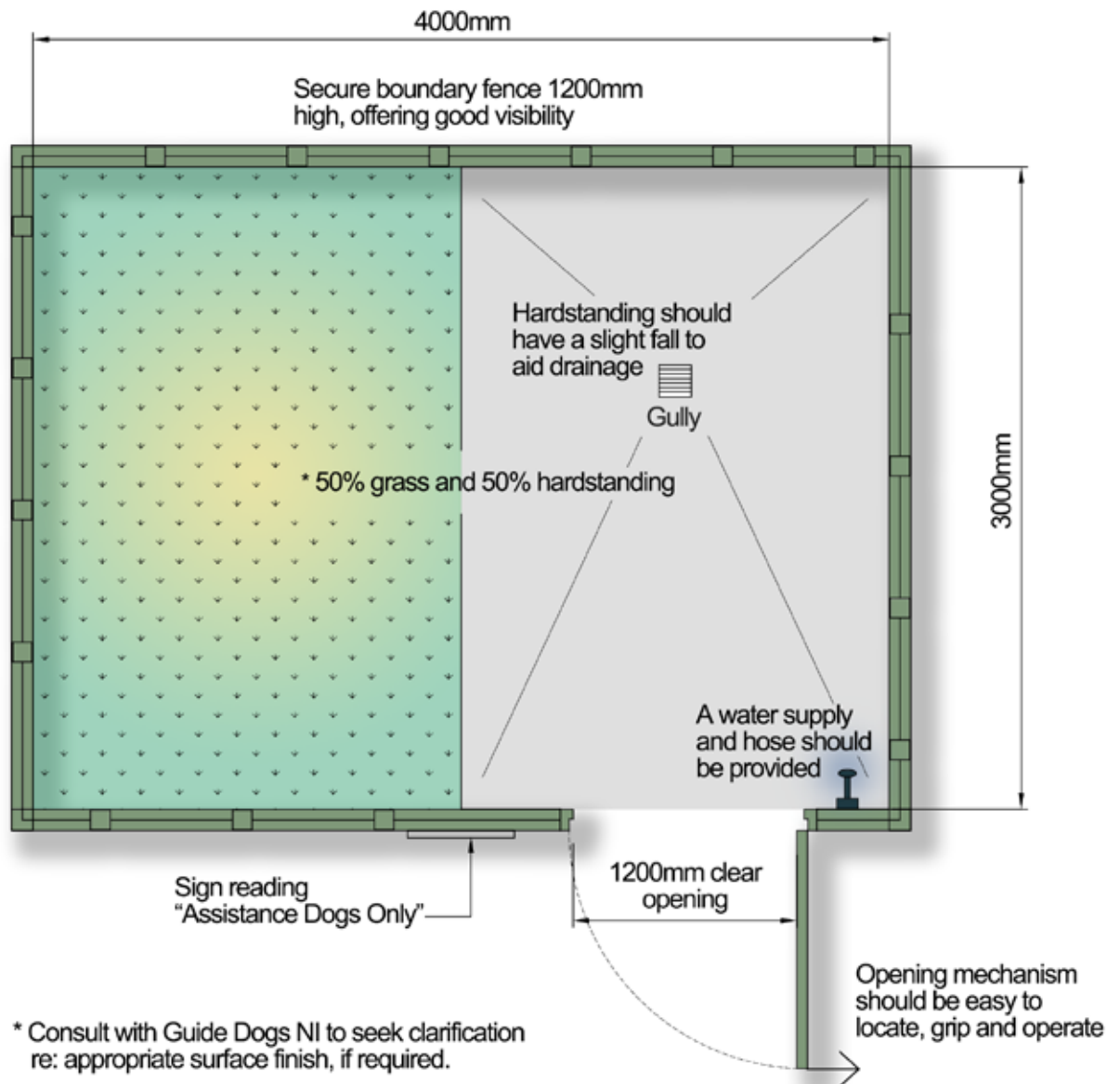

Figure 23 - Assistance Dogs Toileting Facility



Guidance Signpost

- ▶ Guidance on dog toileting facilities for guide and assistance dogs. Guide Dogs.

2.8 RADAR Locks

Overview

RADAR locks are sometimes used in outdoor places e.g. on accessible toilet doors, on gates and to control access to wheelchair accessible swings in play parks. Often this is deemed necessary by site managers for security purposes, for cleanliness reasons, to prevent misuse by non-disabled people and to ensure that equipment is not vandalised.

However, it should be noted that RADAR locks on gates along external routes can be problematic for people with reduced strength or dexterity as they can present difficulties in terms of the position of the lock on the gate and the ability to get on or off, a wheelchair, adapted cycle, scooter or all-terrain vehicle.

Some disabled people prefer the use of a RADAR lock system if it means outdoor facilities are available and clean when they need them and some carry their own RADAR Key; but not all. As such, the use of RADAR locks may render facilities inaccessible to disabled people if they are unable to access a key and/or if they have not been provided with sufficient pre-visit and on-site information.

It is important to remember then that the use of RADAR locks in outdoor places is likely to result in a negative experience for disabled people unless carefully planned, so should only be adopted in well-managed outdoor environments.

Recommended Standards

- As far as possible, the use of RADAR locks should be avoided.
- RADAR locks should only be used in outdoor places where essential for security/cleanliness reasons and where it is possible to easily obtain a key within associated on-site facilities e.g. a visitor centre within close proximity to accessible toilet facilities and play parks, and prior to starting out on an external route.
- If RADAR locks are necessary, this should be clearly stated on pre-visit and on-site route information.
- Where keypad access-control is considered necessary on accessible toilet/Changing Places toilet doors in outdoor places, provide a clear sign that includes contact details to obtain the combination code.
Note: some disabled people may find using a keypad difficult e.g. people who are blind and people with learning disabilities.



Keypad access-control, Changing Places toilet at Canthed Surf Centre, Caswell Bay Swansea (Image courtesy of Surfability UK)

Section

3

Wayfinding, Signs and Information

- 3.1 Pre-visit Information and Maps
- 3.2 Signs
- 3.3 Information Display Boards and Stands
- 3.4 Accessible Information Design and the Use of Contrast
- 3.5 Waymarkers
- 3.6 Tactile Maps, Models and Interpretation Panels
- 3.7 Audio Description and Audio Information
- 3.8 Designing for Colour Blindness
- 3.9 Use of Orientation Cues in Outdoor Places
- 3.10 Using Route Phototrails
- 3.11 Signs on Blueways



Welcome sign using simple, contrasting sans serif font (Image courtesy of RSPB)

Overview

Wayfinding is “a means of enabling a person to navigate, avoid or negotiate obstacles and to identify their destination easily.”⁵

First and foremost, the external environment should be designed, constructed and managed to facilitate clear orientation and wayfinding. Getting disorientated or isolated can be a concern for many people when visiting outdoor places, therefore accessible information and the use of wayfinding tools can help people feel more secure and complements accessible design.

It is important for site managers to develop an accessible information strategy that covers accessibility of the site, in a range of formats including accessible website and social media pre-visit information, maps and photographs. Visitors should also have access to as much information as possible about external routes and suitability when using outdoor places.

3.1 Pre-visit Information and Maps



Site map with symbols key, “You are here” and compass point



Interpretation panel map showing compass point, route distance, cycle routes, symbols key and simple sentence case font, Moyola Nature Reserve



Totem sign including map, Diversity Park Portstewart (Image courtesy of Causeway Coast and Glens District Council)

Recommended Standards

- Pre-visit information must be clear, detailed and include photographs.
- Provide an accessibility statement/guide and details of accessibility features so disabled people can make their own choices. What might be stated as accessible for one person may not be for another, so avoid making assumptions in information provision. Describe the layout and scale of the outdoor place, on-site facilities, landmarks, external routes and the multi-sensory opportunities available.
- Keep accessibility statements/guides up to date to reflect any changes or access improvements made to on-site facilities or external routes.
- Use of sensory guides is also helpful. See Section 3.9 of this guide: Use of Orientation Cues in Outdoor Places.
- Disabled people need to know the degree of accessibility and difficulty of external routes i.e. pathways, trails and greenways. Provide an external route map to classify path difficulty on pre-visit information and at starting/entry points on site.
- External route map information should denote length, potential access barriers such as narrowing or manmade barriers e.g. gates, features of interest, any road crossings required etc.
- Display information regarding the accessibility of potential access barriers to allow disabled people to make an informed choice e.g. steps, slopes and ramps using symbols on maps and on signs.
- External route information should include distance to destinations, not time. **Note:** the annotation of time can mean different things to different people across a range of abilities.
- Develop a trail app to assist people who are blind or partially sighted to navigate and experience features including information details.
- Maps should be available in electronic and hardcopy formats pre-visit.
- The location of information points should be clearly marked on maps. See Section 3.3 of this guide: Information Display Boards and Stands.
- On-site maps and interpretation panels should assist all people e.g. by including tactile embossed text and symbols within the key, tactile features, audio information etc.

3.2 Signs

Recommended Standards

- Signs should be designed as part of a consistent overall wayfinding strategy outdoor places.
- Signs should be logical to avoid clutter and information overload.
- Text-based signs will not cater for all needs e.g. people who do not use English as their first language and should be complemented with information systems such as:
 - Universally recognised symbols for access
 - Simple, tactile embossed symbols or pictograms for common features such as ramps, steps and bridges.
 - Information on architectural/landscape features or landmarks. Smart technology including smartphone apps which can assist people who are blind or partially sighted e.g. audio trail app.
- Routes to, and the location of, key accessible facilities such as parking, transport hubs, information centres and toilets/showers should be clearly indicated, including the use of embossed text on directional and identification signs.
- Directional signs should identify routes that are accessible and step-free e.g. if a diversion or adapted by-pass is put in place to avoid an inaccessible feature or obstruction.
- Provide signs at route starting/entry points, at destinations and along the way where there are particular features, and at key decision points e.g. junctions.
- Where applicable, e.g. on greenways, utilise widely-recognised local government standardisation features for signs i.e. colours and symbols.
- If there are various physical features of the same type along a route e.g. bridges, boardwalks, landmarks etc., consider naming them to reduce potential disorientation or confusion.
- Include directional signs to public transport or wider route network links.
- Temporary signs may be required on event days and to inform visitors of temporary hazards such as fallen trees or maintenance works.
- If a traffic-free section of an external route joins a public road, a sign must be provided to give advanced warning of the hazard ahead.
- For Blueways, see Section 3.11 of this guide: Signs on Blueways.

3.2.1 Location of signs

Recommended Standards

- Sign panels should be located on a firm, level ground surface.
- Signs must be clearly visible on approach in both directions and not obscured by vegetation or parked vehicles.
- Position signs clear of external route width to avoid obstruction or pinch points.
- Signs and safety messages should be positioned at a suitable height to enable reading in a seated or standing position. Countryside for All guidelines refer to the placement of signs within an “accessible cone of vision”, as outlined in Table 3.⁶

Viewing distance	Lowest point not below	Highest point not above
1000mm	800mm	1850mm
2000mm	700mm	2150mm
3000mm	650mm	2400mm

Table 2 - Location of Signs Relating to Viewing Distance

3.2.2 Size of lettering on signs

Generally,

Viewing Distance	x-height (lower case letter)
Short distance	15 to 25mm*
Medium distance	50mm to 100mm* Note: the greater the viewing distance the larger the letter required within this range
Long distance	150mm min.

More specifically,

Reading/Viewing Distance	x-height (lower case font size)	Colour Contrast Examples
1200mm	20	Black on white, blue on white black on yellow, dark green on white, white on red Avoid: yellow font on a coloured backboard; blue on green and black on violet.
1500mm	48	
1800mm	60	
9000mm	200	
18000mm	320	

Table 3 – Sign Font Heights and Colour Contrast Examples

*Embossing preferred for signs within reach, to enable reading by touch.

3.3 Information Display Boards and Stands



Low-level angled interpretation panel with clear knee space, adjacent to external route at Moyola Nature Reserve Riverside Walk



Birdlife information display board using simple, contrasting sans serif font

Overview

Information displays are a convenient method of providing information in the external environment, especially where a visitor centre or associated building is not available and along external routes. Information displays can be in the form of freestanding information boards or boards within covered stands. These are useful at points where people need to make a decision as to where to go or what to do next, particularly first-time visitors. They are also a useful means of conveying information about on-site facilities, the availability of waymarking systems used on-site, features of interest and to warn of potential hazards.

Recommended Standards

- Provide information displays at arrival points (also accounting for arrival by public transport), at entry points to an outdoor recreation area, public park or play park, at the starting/entry point and junctions of external routes, and at key associated on-site facilities.
- Locate information boards on a firm, level ground surface, adjacent to an external route so as not to impede clear width or obscure an interesting feature or view.
- Information board structures should be detectable with a long cane without creating hazard i.e. consistent in depth for the entire height of the board.
- Display boards should have a bottom edge height no lower than 400mm above ground level to accommodate wheelchair footplates.
- Information stands should have an open side to enable easy access, a perch/bench seat, a light and be covered for weather protection.
- Any weather protection canopy above the information board should be not less than 2300mm above ground level (2500mm preferred).
- Information boards and stands should enable close-up reading.
- Information displayed in the range 1400-1700mm above ground level will enable touch reading and information in the range 1150-1250mm will assist people in a seated position.
- Provide a tactile cue at ground level to denote the presence of information display stands, to assist people who are blind or partially sighted e.g. information paving.
- Include:
 - A map showing a clearly defined external route(s), including starting/entry point and destination point.
 - A 'You are here' reference and a compass point. **Note:** availability of Braille compasses and vibrating compasses can assist people who are blind or partially sighted.
 - Route classification status e.g. easy, moderate, difficult.

- Length of the route.
- Details of accessibility features to assist and equally any potential hazards, barriers, or obstacles.
- Key for symbols used on maps and along the route.
- Contact email and/or phone number for use in an emergency.
- Information on assistance dog and general dog access.
- Symbols and pictograms, and photographs. **Note:** pictorial information is always useful to include e.g. to assist people who have learning disabilities.
- Policies regarding free entry for carers and personal assistants, seniors, low income (if charges are applicable).

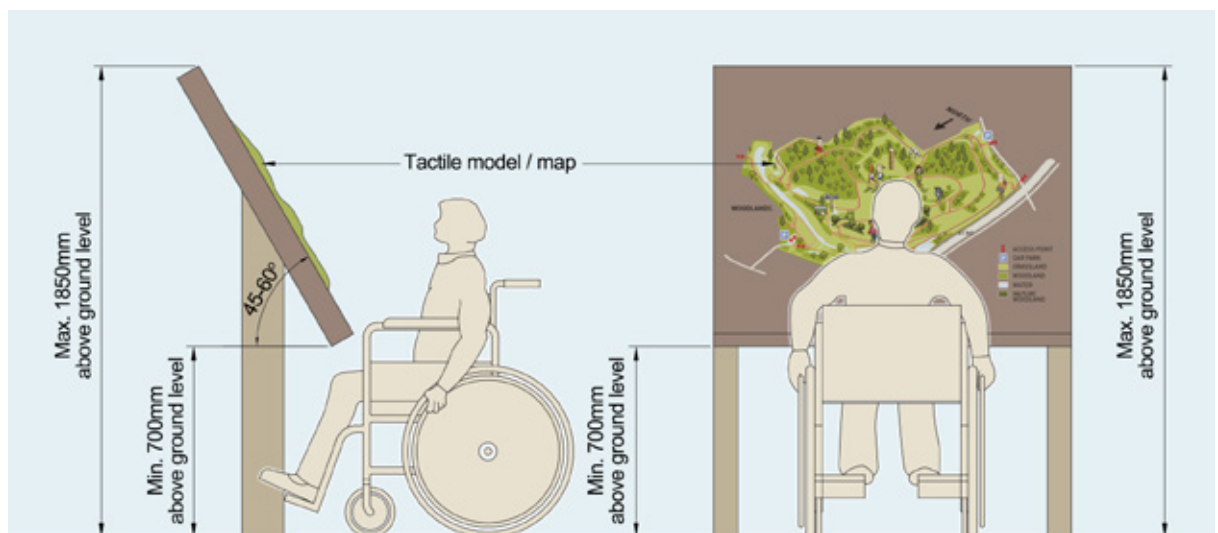

Figure 24 - Interpretation Panels

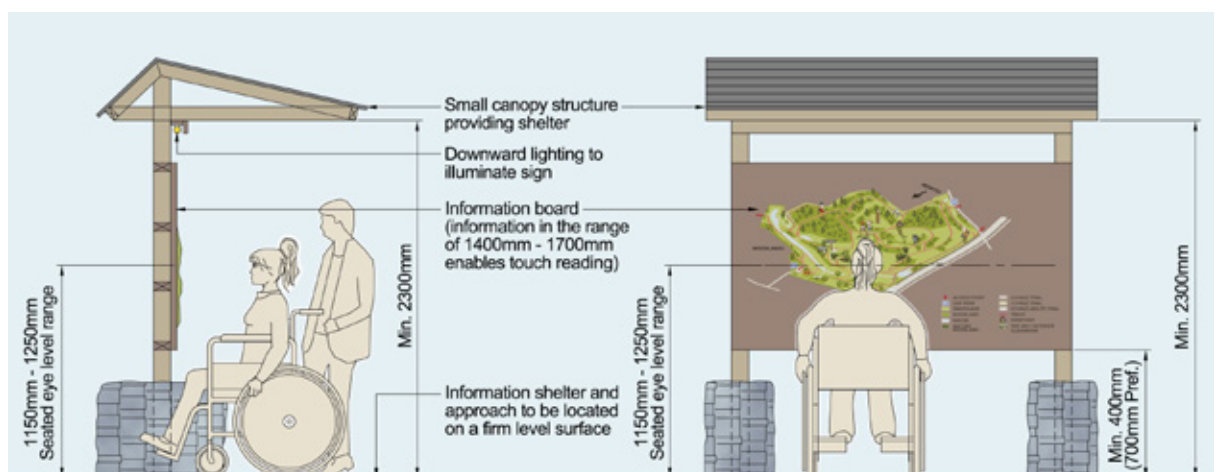

Figure 25 - Information Shelter



Use of angled tactile interpretation board
(Image courtesy of Tandem Design)



Tactile interpretation panel used for rubbings
(Image courtesy of Tandem Design)



Information board on hardstand adjacent
to external route

3.4 Accessible Information Design and the Use of Contrast

Recommended Standards

- Use a suitable font typeface e.g. sans serif font.
- Font size needs to be large enough for people to read the text easily. See Section 3.2.2 of this guide: Size of lettering on signs.
- Use upper and lower case lettering, not block capitals. However, avoid unnecessary combinations of upper and lower case by not capitalising words that don't strictly need to be e.g. the map label on Corry Wood's interpretation panel would read "Old railway embankment cutting".
- Symbols should be universally recognisable e.g. on toilet signs.
- Signs should contrast visually with the background within which they are seen e.g. on walls/doors or the landscape behind (in all seasons). In general, a signboard set against vegetation is best using a white board and black/dark green/blue text.
- Once a designer or site manager has decided on a colour or series of colours appropriate to the site (e.g. green for a forest), an understanding of the colour wheel will guide in establishing a colour scheme.
- Lettering and symbols on signs should offer good colour contrast. For example, black text on white; dark green on white; black on yellow; dark blue on white. Poor colour combinations include pastel on pastel; yellow on orange; yellow on grey; yellow on white; blue on green; red on green; black on violet. A combination of primary, or secondary colours will fail to offer good contrast e.g. green on green.
- Using a matt finish will eliminate glare or dazzle in bright conditions.
- Use the term 'Accessible' rather than 'Disabled' on signs and maps.
- Tactile information assists people who are blind or partially sighted e.g. signs with raised embossed text and symbols, and Braille where applicable e.g. on all toilet and changing/shower facility signs.
- Produce accessibility statements/guides, maps and leaflets in clear Print (14-20 size font for hardcopy information) and offer alternative formats on request e.g. Braille, audio etc.
- Provide audio packs e.g. for self-guided tours.
- Pre-visit information videos with captions will assist people who are deaf or have a hearing loss.
- Pre-visit information should be provided on an accessible website designed in line with Web Accessibility Initiative standards and user tested.
- Provide virtual experiences to assist people who may find challenging external routes and remote environments too onerous e.g. open and wild countryside where often the views are most spectacular.

- Where temporary signs are required, these should comprise sans serif sentence case font with minimum 65 to 70 points Light Reflectance Value (LRV). Matt laminate sheets are available to avoid glare and reflection.



Clear symbols on toilet door,
Springhill House National Trust



Logo for Changing Places toilet
(Image courtesy of Muscular
Dystrophy UK)

3.4.1 Readability

Overview

Easier-to-read content will help all people using outdoor places. Important factors to consider are:

- The average reading age of the UK population is 9 years old.
- People may have a learning disability, such as dyslexia.
- English might not be a person's first language.
- People reading information on a mobile phone device tend to skim over content.
- Some people will be blind or partially sighted.
- People may not have time to read extensive or complicated panels.

These factors are worth bearing in mind when developing route information, interpretation panels, leaflets, pre-visit information etc. to ensure visitor enjoyment and experience.

Recommended Standards

- Written information should be clear and concise to avoid clutter and information overload.
- Text should be broken up into readable blocks.
- Sentences should be short, simple and direct e.g. 10-20 words per sentence.
- Paragraphs should cover one key point each and should not exceed more than 30 words.

- Aim for no more than 150 words on a panel (200 maximum).
- Use bold to highlight key words.
- Use meaningful subheadings (a large block of text can be daunting).
- Use bullet points to summarise content.
- Use no more than two font types.

Within the language, ways improve readability are:

- Avoid using the passive voice. It is subtle but the active voice makes text easier to follow and more interesting.
- Use everyday, familiar language.
- Replace phrases with the simplest alternative e.g. utilise as use, objective as goal.

3.4.1.1 Images

A good photo can be worth 1000 words. Factors to consider are:

- This is what will catch people's eye, draw them to look at the panel and perhaps encourage them to read the text.
- Enlarge photos as much as possible.
- Use a short, snappy caption (state clearly what the photo is, where and when it was taken).

3.5 Waymarkers

Overview

Waymarkers placed at regular intervals and at key points along an external route are a useful information and navigation tool e.g. at junctions on a route or where there is a risk of users diverting from the route.

Recommended Standards

- Waymarkers should be large in size (minimum 100mm diameter), with raised tactile information/symbols, located immediately adjacent external routes at regular intervals. **Note:** on long distance routes greater than 1000m where there are no junctions or change in direction, provide markers at intervals of maximum 500m to offer reassurance.
- All waymarkers must be clearly visible on approach in both directions.
- Use simple pictograms/symbols or distance indicators (colour-coded to match classification systems, where relevant).
- Mark the starting/entry point and destination point, and any junction where a change in direction is required.

- Use waymarker arrows along looped/circular and linear routes.
- Waymarkers should provide directional information in both directions if the route has more than one starting/entry point and to assist people who may wish to turn back or become disorientated e.g. to assist people with Dementia.
- Place waymarker posts next to junctions and extra posts are useful to highlight where people may have missed a turning or joined a different route accidentally.



Sensory trail route marker
(Image courtesy of The Sensory Trust)



Route category waymarker including
All Out Trekking logo, Gosford Forest Park



Directional waymarker at RSPB Portmore
Lough Nature Reserve (Image courtesy of RSPB)



Contrasting route waymarkers, Springhill House National Trust



Clear tactile waymarker showing distance and direction

3.6 Tactile Maps, Models and Interpretation Panels



Tactile finger maze on sensory trail
(Image courtesy of Hand Made Places)

Overview

In external environments, the use of tactile maps, models and interpretation panels can add sensory interest and assist all users, including people who are blind or partially sighted and people with learning disabilities. Interpretation panels also offer play opportunities for children e.g. for doing rubbings.

Recommended Standards

- Provide a tactile guide map which can be used on the go.
- A tactile 3-D model is particularly helpful at an external route starting/entry point to show tactile map information and details of the landscape, routes and on-site facilities.
- Tactile models and interpretation panels placed at 45-60 degrees angle.

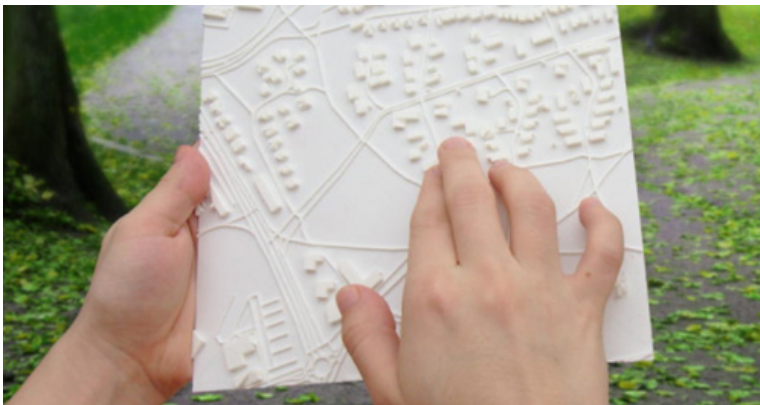

Tactile map on the go (Image courtesy of Touch Mapper)

3.7 Audio Description and Audio Information

Overview

Audio Description is a means of relating the visual qualities of outdoor places using spoken word. This can be useful to enable people who are blind to engage and experience the outdoors in a wide variety of settings e.g. public parks, riverside/forest walks, open countryside and bird reserves.

Methods of conveying audio information include use of Bluetooth, infrared/radio frequency tags systems etc. **Note:** some systems are likely to require an electricity source or solar power.

Recommended Standards

- Pre-recorded audio can assist people who are blind or partially sighted to navigate external routes and sensory trails, as opposed to maps. Recordings should identify any facilities available along the way such as toilets or resting places and directional instruction at junctions. Recordings should relate information on accessibility features to assist orientation e.g. tapping rails, guiding handrails, tactile markers etc. and hazards.
- Where possible, the use of audible signs should be used to highlight features of interest along external routes e.g. listening posts or beacons to describe a habitat, view or to draw attention to site features that might otherwise be missed.
- Messages should be multilingual, with flag annotations to complement.
- Where audible signs are used on external routes or at information stands, assistive listening systems such as an induction loop should be provided for hearing aid wearers, as well as a headphone socket (where possible) for personal headphone use. Wherever practicable, this should be in a quiet area.
- For audio-tactile maps see TacMap.

3.8 Designing for Colour Blindness

Where colour-coding is used on external route signs and waymarkers, colours should contrast strongly with each other to support people with colour blindness. The different conditions are protanomaly, deuteranomaly and tritanomaly. For guidance:

- People with deuteranomaly and protanomaly are collectively known as 'red-green colour blind' and they generally have difficulty distinguishing between reds, greens, browns, and oranges. They also commonly confuse different types of blue and purple hues.
- People with reduced blue sensitivity have difficulty identifying differences between blue and yellow; violet; red and blue and green.

3.9 Use of Orientation Cues in Outdoor Places

Inclusive wayfinding should use spatial, physical, sensory, and environmental cues to help people navigate. Cues should be based on a minimum of two senses.

Recommended Standards

- Create a sensory guide, which includes photographs and information on what you can expect to see, hear, smell and touch. As example, see <https://www.stwater.co.uk/wonderful-on-tap/our-visitor-sites/come-visit-us/carsington-water/carsington-sensory-guide/>

Type	Examples of orientation cues
Visual	<ul style="list-style-type: none"> • Architectural, historical or landscape landmarks. • Signs, information and maps. • Clearly defined external routes e.g. contrasting edge treatment. • Zones within a larger space e.g. play park or public park. • Colour coding, contrast and the use of symbols. • Good lighting that avoids glare and shadowing. • GPS technology and apps.
Audible	<ul style="list-style-type: none"> • Audio signs and interactive multi-lingual listening posts. • An audio walk. • Listening posts and beacons that describe features of interest, including private listening using personal headphones plugged into a jack socket. • PA systems where relevant. • Use of sensory water features. • Nearby sounds such as rivers, road traffic to left or right. • GPS technology and apps.
Scent	<ul style="list-style-type: none"> • Planting and flowers. • Encouragement to smell at various route markers e.g. use of scratch panels.
Tactile	<ul style="list-style-type: none"> • Embossed tactile signs and Braille where practicable. • Changes in level and kerb upstands. • Tapping rails and guiding handrails. • Changes in ground surfaces e.g. tactile markers/information paving at key features. • Sensory touch features e.g. tactile maps and sensory panels. • Encouragement to touch at various route markers e.g. tactile NXT sound exciter.

Table 4 - The Use of Orientation Cues

3.10 Using Route Phototrails

Overview

Phototrails assist all users to familiarise themselves with outdoor places and specific accessibility features/hazards on external routes in advance of a visit by offering a pictorial resource to view external routes and what the adjacent landscape/countryside looks like. This enables disabled people to make informed decisions about suitability and can be particularly helpful for people with neurological differences, such as Autism.

Recommended Standards

- Develop a phototrail of external routes, including sensory gardens and sensory trails.
- Include photos taken in the direction of travel from arrival points/parking areas to show ground surfaces, potential barriers such as gaps and gates, slopes, manmade or natural features of interest, fishing points, access to water facilities, resting places, points of narrowing on route sections, passing places (if applicable), orientation landmarks etc.



Guidance Signpost

- ▶ Accessibility standards. Setting standards for countryside paths and trails. A good practice guide to disabled people's access to the countryside. Countryside for All Fieldfare Trust Ltd. Updated 2005.
- ▶ Sensing Nature Project. Designing urban green space with sight impairment in mind. Dr Sarah Bell. University of Exeter and Economic and Social Research Council. 2017.
- ▶ Sign Design Guide. A guide to inclusive signage. JMU and the Sign Design Society. Parker, P & Fraser, J. 2000.
- ▶ Disability Sport NI Guide 1: Accessible Sports Facilities Design Guidelines (2020 Edition). Section 6: http://dsni.co.uk/files/Guide_1_Accessible_Sports_Facilities_Design_Guidelines.pdf
- ▶ Touch Mapper: <http://touch-mapper.org/en/>
- ▶ Sensing Nature Project and VocalEyes. Supporting multisensory visitor experiences at natural heritage settings. Audio description and access guidance for staff and volunteers.
- ▶ <https://www.color-meanings.com/color-wheel-theory-complementary-colors/>
- ▶ www.colourblindawareness.org
- ▶ TacMap: <https://www.shu.ac.uk/business/see-our-impact/case-studies/tacmap>
- ▶ Phototrails: <https://www.phototrails.org>
- ▶ Vocaleyes: <https://www.vocaleyeyes.co.uk/services/resourcesdescriptive-directions-and-information-for-blind-or-partially-sighted-visitors-to-arts-venues>

3.11 Signs on Blueways

Overview

Reasonable steps must be undertaken to make Blueways accessible for disabled people. As well as in outdoor places associated with green infrastructure, wayfinding, information and signs are also important when considering the accessibility of blue infrastructure i.e. Blueways.

Considerations for the consistent signing of Blueways are as follows:

- Avoiding clutter whilst maintaining a good level of support.
- Denoting positivity not highlighting limitations.
- Clear directional information, leading to and at the Blueway trailhead and at junctions.
- Appropriate use of national and regional public signs.
- Blueway trailhead identifier sign clearly displayed and visible at the access point and the use of clearly visible trailhead information panels (for water-based and land-based activities on the same trail, including water-based information panels close to the water).
- Signs should include all relevant information such as the trail entrance, egress and exit points, length, difficulty, map with symbols, scale and compass points, obstacles, contact details etc.
- Colour-coded markers indicating the safe or navigable heights of water levels on river Blueways.
- Use of windsocks or flags e.g. to denote wind direction and strength.
- For further guidance see Blueways Signage Guidelines.
- See also Section 3 of this guide: Wayfinding, Signs and Information.



Guidance Signpost

- ▶ Blueway Management and Development Guide. Blueways Ireland. 2020.
- ▶ <https://www.sportireland.ie/outdoors/blueway-development>
- ▶ Blueways Ireland Advisory Note 1. Guidance Notes on Blueway Development & Management. “Achieving the Criteria”. Prepared by Outdoor Recreation NI on behalf of the Blueway Partnership.
- ▶ Blueways Ireland Advisory Note 3. Blueway Signage Guidelines. Prepared by Outdoor Recreation NI on behalf of the Blueway Partnership. <https://www.dttas.ie/roads/publications/english/traffic-signs-manual-2010>
- ▶ <https://www.infrastructure-ni.gov.uk/sites/default/files/publications/drd/the-signing-of-tourist-attractions-and-facilities-rsppg-e029.pdf>

Section

4

Access to Water

- 4.1 Access to Water-based Activities
- 4.2 Jetties and Pontoons
- 4.3 Slipways and Gangways
- 4.4 Hoist Provision and Equipment
- 4.5 Accessible Angling Facilities
- 4.6 Access to Beaches



EZ Launch system (Image courtesy of EZ Dock)

4.1 Access to Water-based Activities

Overview

Water-based activities should be planned and designed to be accessible to everyone including disabled people. This should include the provision of accessible external routes leading to the water and the provision of facilities that enable disabled people to safely and easily enter and exit the water e.g. transfer onto a boat, or egress from the water in open water swimming. Key amenities such as jetties, pontoons and fishing stands should be designed to be inclusive of disabled people.



Guidance Signpost

- ▶ Overcoming Barriers to Outdoor Recreation for Disabled People. Outdoor Recreation NI:
http://www.outdoorrecreationni.com/wp-content/uploads/2012/04/Toolkit-to-Success-Making-Outdoor-Activities-Accessible_ORNI-2012.pdf
- ▶ Blueways Ireland Management and Development Guide:
https://www.sportireland.ie/sites/default/files/2019-10/blueway-management-development-guide_0.pdf

4.2 Jetties and Pontoons

Overview

Disabled people should be afforded the same opportunities to participate in water-based activities as non-disabled people including on rivers, marinas and harbours etc. Making improvements to the existing shoreline, the development of well-designed Blueway infrastructure and the provision of equipment is key.

Jetties are fixed structures used where no water level changes are evident, but equally can be submerged during floods or high tides. A pontoon dock is a floating structure to account for rise and fall during tidal and water level changes.

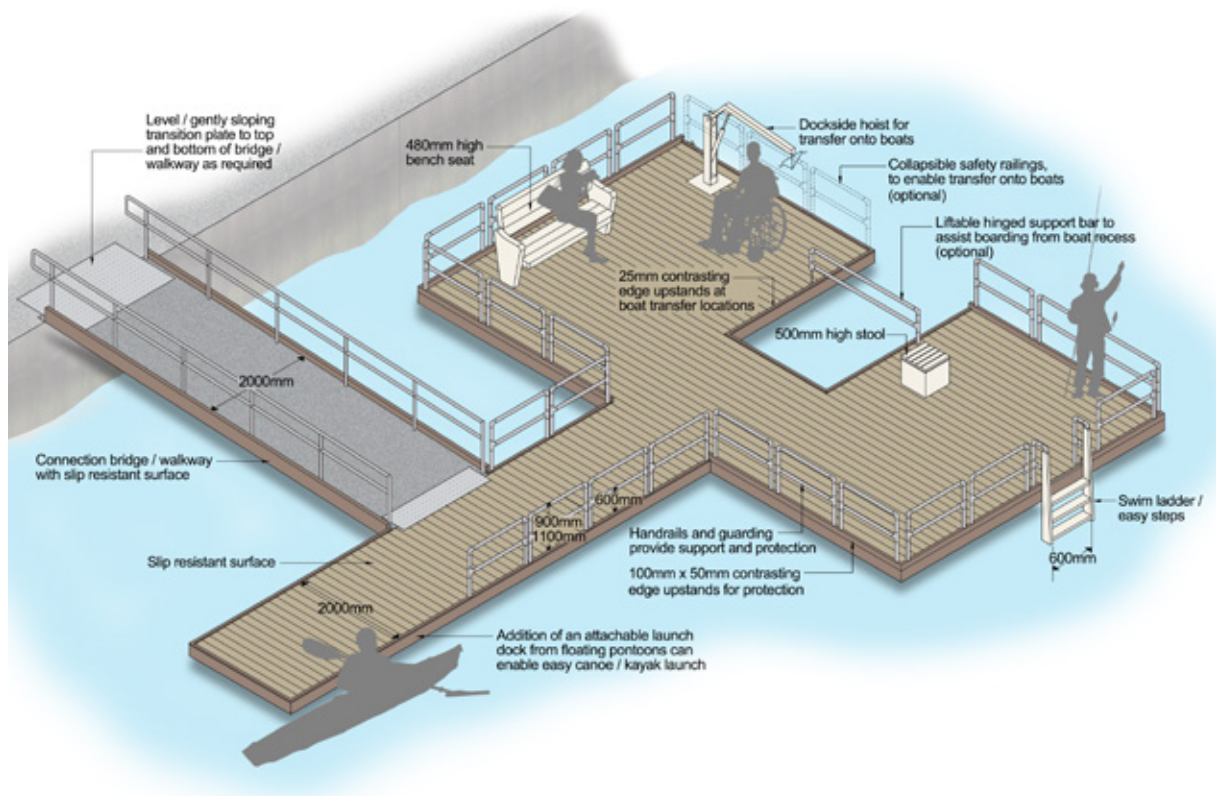

Figure 26 – Floating Pontoon



Floating angling pontoon with Wheelyboat and EZ Kayak Launch at Patshull Park Fishery (Image courtesy of The Pontoon and Dock Company Ltd)



Pontoon walkway with sloping transition plate, Foyle Marina



Floating pontoon, Foyle Marina

4.2.1 Approach to jetties and pontoons

Recommended Standards

- Approach road entrances to water-based activity sites should be minimum 5000mm wide to allow two vehicles to pass each other if no passing places are provided, or minimum 3000mm width with regular passing places extending the width to 5000mm.
- Access restriction systems such as barriers and gates should be avoided where possible.
- Parking in accordance with Section 1.1 of this guide: Parking and Setting-down should be provided to serve jetty and pontoon facilities. Only where sufficient land is unavailable for parking should setting-down only be permitted e.g. adjacent to a marina dockside. Site managers could offer a transfer buggy system to transport disabled people from the nearest accessible parking facility e.g. during galas.
- If launching directly from the shore, the shoreline section should be firm and smooth. **Note:** heavy duty matting can provide support on softer or muddy ground surfaces. See Section 4.6.3 of this guide: Beach boardwalks and accessible external routes.
- External routes leading to jetties and pontoons should be in accordance with Section 1.2 of this guide: Accessible External Routes - Paths, Trails and Greenways.
- Provide a firm, slip resistant ground surface which enables easy access. In some settings, well-compacted grass, gravel, whin dust blinding may be acceptable on external routes leading to water-based activities. See Section 1.2.5 of this guide: External route ground surfaces.
- For routes which cross sand or dense grass, see Section 4.6.3 of this guide: Beach boardwalks and accessible external routes.
- If steps are essential from parking/setting-down areas to reach a ramp or connection bridge onto a jetty or pontoon, a lifting device should be provided as an alternative.
- Ramps and connection bridges to access jetties and pontoons should be maximum 1 in 21 and 2000mm wide. Contrasting handrails and minimum 100mm upstand edges are required for safety and to offer guiding assistance to people who are blind or partially sighted. **Note:** where tidal conditions impact gradient, some exceptions may be considered acceptable at certain times of the day. However, where a gradient may prove particularly steep or onerous, safe access should be restricted to times dictated by the tide.
- Any control gates/barriers leading onto jetties and pontoons should include clear signs and information, including contact numbers and easy to use controls and locks at an accessible height (600-1000mm above ground level preferred; maximum 1200mm).

- Where connection points are unavoidable between the shore/bank and jetties, provide level transition plates i.e. no steeper than 1 in 21.

4.2.2 Design features of jetties and pontoons

- Jetty and pontoon walkways should be minimum 2000mm in width to allow clear passage in both directions on the structure.
- Provide minimum 100mm high by 50mm edge upstands for protection generally which contrast visually with the remainder of the jetty or pontoon surface and the water.
- The junctions between sections of walkway on jetties and pontoons should be flush, with joints/gaps between sections or boards maximum 5mm (10mm absolute maximum). Where used, boards should be laid perpendicular to the line of travel.
- Floating pontoons flush with boat level will assist transfer onto and off boats.
- Where possible, provide a form of shelter on jetties and pontoons.
- Jetties and pontoons should have a matt, slip resistant surface in all weather conditions (minimum mesh GRP surface).
- Handrails and guarding provide support and protection. Handrails 900-1100mm and 600mm high should be installed.
- Protective netting could be provided between handrails.
- Collapsible handrail sections can provide protection whilst allowing clear transfer zone onto boats when required.
- Mooring cleats, service points etc. should be positioned carefully on the contrasting upstand edges.
- Services and controls should be located at an accessible height 750-1000mm above ground level (maximum 1200mm).
- There should be a clear space minimum 900mm by 1400mm adjacent to services (1500mm by 1500mm preferred to allow clear turning).
- **Note:** if the slope has to be greater than 1 in 21, a level landing is required at the end of the transition plate on-shore.
- Provide a means of transfer onto boats from jetties and pontoons. See Section 4.4 of this guide: Hoist Provision and Equipment.
- Provide clear space minimum 1500mm wide adjacent to boarding sections. **Note:** 25mm upstands to boarding sections where handrails are not installed, or collapsible handrails are installed will still enable transfer.
- Jetties should be maximum 450mm above the water for canoeing, 180mm for rowing and sailing (alternatively, an accessible slipway to the water is suitable).
- Jetties should be maximum 200mm above the water for swimmers.

- Provide pontoon ramped access which adapts to changes in level and easily accessible from toilet and changing/showering facilities.
- Provide sound beacons on jetties and pontoons to assist swimmers at the point of descent/ascent from the water and canoeists/kayakers who are blind or partially sighted.
- Any specific areas designated for swimmers who are blind or partially sighted should be clearly defined and highlighted e.g. designated zone within an open swimming marina setting.
- Provide a lifting platform and easy steps with contrasting nosings to assist swimmers to access the water.
- Easy steps should have 300-450mm treads, minimum 600mm wide, starting 500mm high above the jetty surface.
- Provide a recess to enable ascent from the water using arms, 600mm wide and 350mm deep. Additional ladder steps should be provided, 600mm wide.
- See Section 4.2.4 of this guide: Modular floating pontoon ramps and floating systems.



Floating pontoon at Craigavon Water Sports Centre



Fixed jetty/viewing platform



Rest bench seat for use on jetties and pontoons
(Image courtesy of EZ Dock)



Guidance Signpost

- ▶ ADA Checklists: <https://www.ADAchecklist.org>
- ▶ Blueways Ireland Management and Development Guide: https://www.sportireland.ie/sites/default/files/2019-10/blueway-management-development-guide_0.pdf

4.2.3 Berthing

Overview

The ability to moor accessible boats on a jetty or pontoon, either to facilitate boarding along the side or by the stern, is essential.



Fixed jetties and berths; and level transition from car park at Ballyronan Marina

Recommended Standards

- Where multiple berths are provided at a marina or along a pier, at least one accessible berthing pontoon to serve 5% of berths should be fitted with a hoist and multiple sockets.
- Berthing pontoons should be rigid to avoid whiplash and minimum 1200mm wide between mooring cleats. An extra wide pontoon/pier finger, minimum 2000mm, should serve accessible berths.
- Provide minimum 900mm by 1400mm clear space at an accessible cleat (1500mm by 1500mm preferred to allow clear turning).
- Accessible berths may be grouped together if consideration has been given to water depth, short or longer-term lease, sheltered or unsheltered and services such as telephone, water and electricity supply.
- An accessible boat berth should be clearly marked using a symbol sign, so that it is easy to identify on arrival at the marina or dock.
- Provide a 500mm high bench seat alongside accessible boat berths.

4.2.4 Modular floating pontoon ramps and floating systems



Floating pontoon EZ Dock (Image courtesy of The Pontoon and Dock Company Ltd)

An accessible means of exiting water is required for open swimmers, in addition to step ladders e.g. a modular floating pontoon ramp can enable quick egress from the water for open water swimmers with a broad range of abilities and can be retained on the water on a temporary or permanent basis. As example, the Aqua-dock pontoon system includes a semi-submersible platform, making lateral transfer into boats easier. It comprises 500mm modular blocks which attach to the water's edge using arms/chains to form a ramp. The end floats approximately 200mm below the water's edge so that participants can access the ramp easily.



Aqua-dock floating pontoon ramp used for Belfast Titanic Triathlon, Derry City Triathlon and Irish Paratriathlon Championships 2018 (Image courtesy of Community Multisport)



EZ Dock pontoon system with transition plate (Image courtesy of The Pontoon and Dock Company Ltd)

Modular floating pontoon systems can also be used to form floating jetties, platforms and slipways e.g. a platform for people to access canoeing, kayaking and sailing boats. Any floating pontoon system should include hoists to assist wheelchair users to transfer into boats.



Hansa accessible H-Dock floating pontoon system
(Images courtesy of Hansa)



EZ Dock floating pontoon system and Hereford Hoist dockside
(Image courtesy of The Pontoon and Dock Company Ltd)



Guidance Signpost

- ▶ Aqua-dock: <https://aqua-dock.co.uk>
- ▶ Pontoons Ireland: <https://pontoonsireland.ie>
- ▶ Pontoon and Dock Company Ltd: <https://pontoonanddock.com>
- ▶ Community Multisport: <https://www.communitymultisport.org/>
- ▶ Hansa: <https://www.hansa.com>
- ▶ EZ Dock: <https://ez-dock.com>

4.3 Slipways and Gangways

Overview

A slipway is a slope used to launch boats into the water. A gangway is a sloped walkway that links a fixed structure, or the shore, with a floating structure/vessel. As water levels rise and fall, gangway slopes do also. To ensure a gangway is accessible, gangways should always be designed for the least restrictive slope that will provide independent access for disabled people.



Gangway access from shore (Image courtesy of EZ Dock)

Recommended Standards

- Provide a permanent sloped slipway no steeper than 1 in 15, fitted with a winch system for launching and retrieving boats.
- If temporary boat moorings are part of a slipway, at least one or 5%, whichever is the greatest, should be accessible for disabled people.
- Where gangplanks are required for use at connection boats, the width, surface, gradient and support must be carefully considered. Where possible, ramped standards should be applied. **Note:** it is recognised that, in some circumstances, long length gangways without intermediate landings may only be feasible e.g. where greater rises have to be overcome. If so, as a minimum aim for maximum slope 1 in 12 wherever possible.
- Where possible, add a lift to overcome particularly steep inclines which may be inaccessible or unnerving for disabled people.
- Gangways should be minimum 1200mm wide with railings on both sides, 900-1100mm high and extending 300mm beyond the gangway forming a closed end.
- Railings can comprise mesh or canvas if there is good grip at the top.
- Provide a firm, slip resistant surface.

- Provide a transition plate at the end of a gangway i.e. sloped walking surface. Gangways are not required to have landings at the end, if transition plates are provided. If the slope of a transition plate is greater than 1 in 20, the transition plate must have a level landing at its non-gangway end.
- If there are railing extensions on gangways or transition plates, the extensions are not required to be parallel with the ground surface.
- Where gangways and transition plates connect, handrail extensions are not required.
- Ensure maximum 1 in 50 crossfall on gangways.



Guidance Signpost

- ▶ ADA Checklists: <https://www.adachecklist.org>

4.4 Hoist Provision and Equipment

Overview

The ability to transfer safely into and out of boats, and the water, is an essential element in providing access for disabled people. Activity providers and leaders must determine the safest methods for doing so based on specific water-based tasks, in conjunction with additional dockside and on-board equipment. Standard methods include steps, floating low-profile or flush dock systems, a hinged ramp with handrails. However, hoists, mechanical or water-powered lifting platforms and easy launch options also offer alternative means of assisting disabled people to transfer to and from boats, and the water, from a jetty or pontoon.

4.4.1 Hoists

Overview

Hoists that can be mounted on jetties and pontoons are available to assist transfer into and out of boats. Generally, mounts will be permanently located on the dock and the hoist arm can either be removed for storage elsewhere or mounted permanently on the dock.



Hoist provision at Lough Erne Yacht Club
(Image courtesy of Lough Erne Yacht Club)

Recommended Standards

- Provide a hoist for transfer from jetties and pontoons onto boats if the change in level is greater than 400mm.
- Hoists must be certified and capable of supporting significant body weight capacity.
- Hoists must be mounted securely and in a convenient position to enable transfer accounting for the location of accessible berths, transfer sections and tidal conditions resulting in level changes.
- A hoist is useful if mounted on the outside corner of a dock where it can be used front and side.
- Slings/harnesses that support the back and buttocks, and that cross between the legs, help to prevent a person from sliding out during transfer from hoist to boat. **Note:** where possible, it is always best if a disabled person brings their own personal sling/harness as it will be suited to their individual needs.

Some examples of hoists are shown below.



Crew Lift hoist system (Images courtesy of Caley Marina)



The Crew Lift Davit System can be mounted dockside on jetties and pontoons and is operated using simple hydraulic controls at accessible heights. The heavy duty stainless steel system rotates 360 degrees and transfer is enabled using the telescopic extendable arm. Load capacity up to 160kg.

- Hereford Hoist



Hereford hoist on floating pontoon with EZ Kayak Launch
(Image courtesy of The Pontoon and Dock Company Ltd)



Hereford Hoist (Images courtesy of The Pontoon and Dock Company Ltd)

Hand-operated hydraulic hoist, which can be supplied with a base unit to fit almost any type of pontoon system.

- Hansa C-Crane Hoist and H-Dock system



Hansa C-Crane Hoist and H-Dock System – accessible transfer system to access Hansa 303 boats (Images courtesy of Hansa)

This system provides an accessible floating dock to access the water from the shore and mounted C-Crane Hoists to enable multiple transfers into boats from the dock system.



Hansa T-shape pontoon and C-Crane (Image courtesy of Hansa)

- Oxford Dipper Hoist



Oxford Dipper Hoist (Image courtesy of Royal Yachting Association)

Other hoists available include the Wispa 12V Electric Hoist, Oxford Mermaid Hoist and Hydraulic Hoyer Hoist, Splash Mariner Semi-portable dockside aquatic lift.



Oxford Mermaid Hoist - manual
(Image courtesy of Joerns Healthcare)

4.4.2 Easy launch options and additional equipment for accessible water-based activity

Additional equipment to assist disabled people with different needs to board boats, enter and use the water is also an important consideration in accessible outdoor places. For example, easy launch and low-profile dock options, transfer boards and boxes, bosun's chair, gripping aids etc. **Note:** unstable bumpers such as wide rubber tyres between jetty and boat can make transfers more difficult.

- **EZ dock and launch system**

EZ Kayak Launch for kayaks and canoes can be attached to the existing dock or docks designed using the Standard Height or Low Profile EZ Dock.



EZ Kayak Launch showing fixings to dock and slide transfer (Image courtesy of EZ Dock)



EZ Kayak Launch (Image courtesy of The Pontoon and Dock Company Ltd)

- **Solent Bosun's Chair**



(Image courtesy of Baseline Marine Products Ltd)

This canvas Bosun's Chair is specially designed for lifting disabled sailors into boats from their wheelchair on a jetty or pontoon.

- **Transfer benches and boards**

These provide a more suitable transfer option for people with good upper body strength who do not require a hoist.

A transfer bench has a hinged board attached, which when open provides slide transfer from the bench to the boat. A sliding board allows direct transfer from a wheelchair to a boat.



Launch transfer slide bench (Images courtesy of EZ Dock)



Curved Glideboard (BananaForm) slide board
by Samarit of Switzerland

- **On-board aids**

Support systems such as the Equal Adventure Aquabac is designed for children and adults who require seated balance assistance. Gripping aids can assist people with reduced hand/wrist function or strength when using canoes and kayaks, or when fishing.



Adult Aquabac (Image courtesy of Equal Adventure)



Hand and wrist grip and Strong Arm fishing aid (Images courtesy of Active Hands)

4.4.3 Accessible boats and canoes



Hansa 303 at Access World Championships Sydney 2012 (Images courtesy of Hansa)

Accessible boats are available to improve access to water-based activities for disabled people. For example, Coulam V24 Wheelyboat with hydraulic platform to avoid the need to step into a boat, the Hansa 303, the Pioneer Wheelchair Multi, adapted canoes, kayaks, catamarans, dinghies, longboats and windriders. A clamping system on boats is best for the safety and security of wheelchair users, as opposed to the sole use of brakes.

Recommended Standards

- Where an access ramp is used to transfer onto a boat it should be minimum 800mm wide, comprise a slip resistant finish and gradient maximum 1 in 15 (maximum 1 in 21 preferred).
- Side doors on boats can provide access if minimum 800mm wide.
Note: some charter boats provide wheelchair access using the diver side access feature.
- Boats should have a slip resistant finish on board and the surface of any access point onto boats should be slip resistant.
- Unlike sea boats, freshwater fishing boats are often self-operated and as such should have accessible controls so disabled anglers can operate them independently.
- As some disabled anglers will require support to operate anchors independently an anchor system with a mechanical or electrical winch should be considered.

- Adapted kayaks/canoes



Adapted kayaks/canoes (Images courtesy of British Canoeing)

Adaptations to kayaks/canoes can include, but are not restricted to: seating with high backrest for support in place of bench seat, padding to extend footrest, sponge style padding at each side of the seat to assist paddlers with reduced balance.

Paracanoe is the competitive side of the sport, with a Paralympic pathway for athletes with a physical disability: Paracanoeing uses two types of boat, the traditional Kayak (double sided paddle used) and the Va'a - a canoe with an outrigger to provide stability (single bladed paddle used). See examples below.



(Images courtesy of International Canoe Federation/PlanetCanoe)

- **Wheelyboat**



Example of easy access Wheelyboat

Wheelyboats have been designed to enable easy access onto and off the boat using a hinged bow door that lower to create ramped access. A variety of Wheelyboat models are available e.g. the Mk III Wheelyboat can be used for a range of activities including angling and has a slip resistant aluminium treadplate.

- **Hansa sailboats**



Sailing Hansa 303 at Lough Erne Yacht Club
(Images courtesy of Lough Erne Yacht Club)

Hansa sailboats, such as the Hansa 303, are designed and built on the principles of universal design. Rather than having particular features which associate them with being accessible for disabled persons, Hansa sailboats are designed to be sailed by everyone regardless of whether they are disabled or non-disabled. Hansa's World Championship regattas are open to all people and frequently are won by a sailor with a disability. The Hansa 303 has been selected for use at Para World sailing events. Keel lockdown is imperative to the safety of using Hansa boats.



Guidance Signpost

- ▶ The Wheelyboat Trust: <https://www.wheelyboats.org>
- ▶ Royal Yachting Association: <https://www.rya.org.uk/programmes/rya-sailability/equipment-directory/Pages/hub.aspx>
- ▶ Sailing for Everyone Foundation Inc: <https://s4e.org/philosophy/>
- ▶ Chiltern Invadex: <https://chilterninvadex.co.uk>
- ▶ Great Outdoors. A Guide for Accessibility. Irish Wheelchair Association Sport and Sport Ireland. October 2018.
- ▶ Active Hands: <https://www.activehands.com>
- ▶ Equal Adventure: <https://www.equaladventure.co.uk>
- ▶ Hansa: <https://www.hansa.com>
<https://www.youtube.com/watch?v=6qod8dpfUOw>
- ▶ Hansa at Access World Championships Sydney 2012: <https://vimeo.com/116919764>

4.5 Accessible Angling Facilities



Accessible angling group platform designed to British Disabled Angling Association standards (Image courtesy of The Albrighton Trust)

Overview

Suitable angling positions include manmade riverbanks, on-bank fishing stands and fixed over-water jetties/platforms from which to fish or board a fishing boat. Lack of accessible toilet provision is a barrier to people participating in angling activities. The journey to accessible angling facilities, as well as the position and accessibility of specific angling facilities are equally important. For example, accessible parking bays and toilets should be located as close as possible to accessible angling facilities, external routes leading to accessible angling facilities should be suitably designed and accessible angling facilities should be suitably designed and clearly marked using symbol signs.

Features to consider in the design of accessible on-bank fishing stands and over-water jetties/platforms are as follows:

- Provision and proximity of accessible parking and toilet provisions.
- Accessible external routes leading to the riverbank and on-bank fishing stands. See Section 1.2 of this guide: Accessible External Routes - Paths, Trails and Greenways.
- Accessible external route and transition onto over-water jetties/platforms from the shore. See Section 4.2 of this guide: Jetties and Pontoons.
- Firm, slip resistant surface finishes e.g. recycled plastic decking with slip resistant finish.
- Suitable size, depending on specific use.
- Protection and support in the form of guardrails and handrails, where required.
- Distance from the end of stands to the water.
- Resting places, seating and tables.

Recommended Standards

- For accessible parking and toilets, changing and showering facilities see Section 1.1 of this guide: Parking and Setting-down, and Section 2.5 of this guide: Accessible Toilets, Changing and Showering.
- Angling facilities should be accessible directly from an external route, or via a gentle slope or connection ramp, minimum 2000mm wide. **Note:** an adjustable height ramp may be required in some locations to account for tidal conditions or changes in water level when accessing an over-water platform.
- Provide protection from the wind along the accessible external route leading to accessible angling facilities and behind on-bank fishing stands e.g. hedge, bushes or fencing. **Note:** for fly fishing, suitable clearance is required for casting (minimum 25-30m of open bank to the rear and side of the fishing stand).

- Provide resting places along the accessible external route. See Section 2.2.1 of this guide: Resting places.
- At the start and along the accessible external route, include information to assist disabled anglers e.g. distance to the nearest accessible on-bank fishing stand or over-water platform, width of the external route if narrowing will occur and stand/platform size annotations (i.e. suitable for one-person angling, or groups).
- Accessible on-bank fishing stands should be integrated with other angling points and clearly marked using symbol signs (tactile embossed).
- Commonly, solid surfaces such as concrete, recycled plastic decking and timber with a slip resistant finish or self-binding gravel are used for on-bank fishing stands. See Section 1.2.5 of this guide: External route ground surfaces.
- Provide a minimum clear turning circle 1500mm by 1500mm on any on-bank fishing stand and over-water platform (greater space will be required to accommodate groups of disabled anglers). See Section 4.5.2 of this guide: Size and design of on-bank fishing stands and over-water platforms.
- Provide a bench seat 500mm high for ambulant disabled anglers.
- Provide a table for wheelchair users to use bait.
- Install rod clamps/holders on rails. Where armrests and rod holders are provided on the top of an on-bank fishing stand they should be inclined at 30 degrees. Armrests should be 800-850mm high for seated anglers and 1050-1170mm high for standing anglers. **Note:** some wheelchair anglers may have attachments on their own wheelchair to support their fishing rod.

4.5.1 Boardwalks leading to angling facilities

Accessible boardwalks, or sections of boardwalk, may be necessary to enable easy access along or from adjacent external routes to the riverbank or platforms e.g. to overcome muddy areas.

Recommended Standards

- Commonly, surfaces such as traditional, pressure treated timber, composite decking, pre-cast concrete and modified timber are used for this purpose. Any timber or composite material must have a slip resistant finish.
- Boardwalks and platform walkways should have protection where the surface is higher than the ground adjacent and where a clear space is not required to give access to the water or boats e.g. guardrails.

4.5.2 Size and design of on-bank fishing stands and over-water platforms



Fishing platforms, Dungannon Park (Images courtesy of Mid Ulster District Council)

The British Disabled Angling Association has identified six options for the size and design of fishing “stations” i.e. for on-bank stands or over-water platforms.⁷ These six options provide access, flexibility of use, stability and safety, across a variety of situations for individuals, pairs and groups, or during competitive angling.

The sizes relate to three types of fishing station – single individual use platform, double platform at twice the size and group/training platform:

- Single station – for independent one-person use, or to accommodate a companion, assistant, fishing coach or parent.
- Double station – for two or three wheelchair users.
- Large group/training station – for up to six wheelchair users, multiple anglers, angling groups, schools and coaches.

Figure 27 of this guide: Design Options for Accessible Fishing Stands and Platforms, has been based primarily on these six options.

⁷ British Disabled Angling Association. BDAA National standard of “accessible for all” platforms.

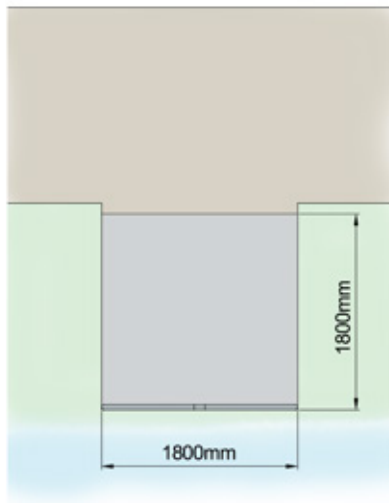

**On-bank platform 1800mm x 1800mm
(1800mm x 2400mm preferred)**

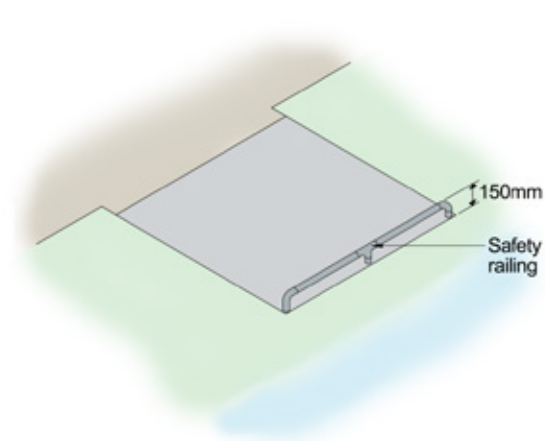

Note:
On-bank platforms that are flush with the adjacent ground do not require protective side safety railings. Any low-level upstand at the sides could present a potential trip hazard and should be avoided. Platforms that are higher than the adjacent land or water, including on-bank platforms that have an exposed side/s, require protective side safety railings.

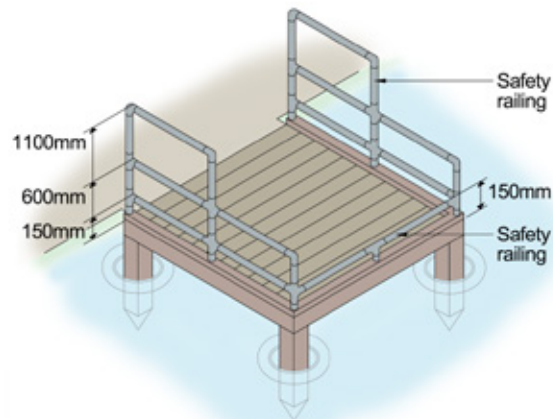
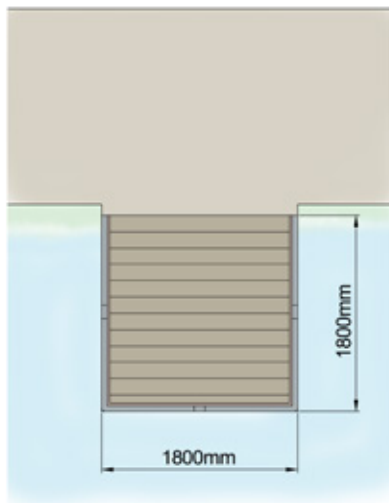
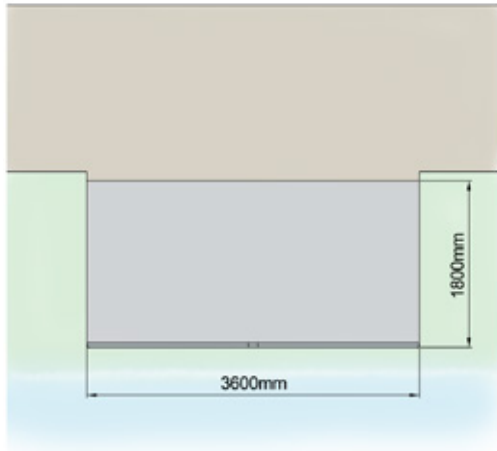
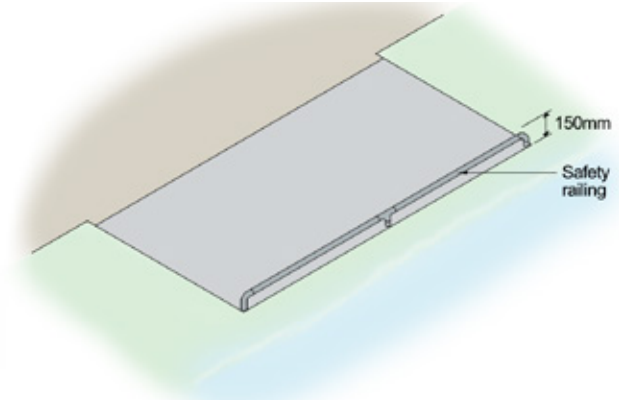

Diagram A - Fishing Platform 1800mm x 1800mm



On-bank platform 3600mm x 1800mm



Note:
 On-bank platforms that are flush with the adjacent ground do not require protective side safety railings. Any low-level upstand at the sides could present a potential trip hazard and should be avoided. Platforms that are higher than the adjacent land or water, including on-bank platforms that have an exposed side/s, require protective side safety railings.

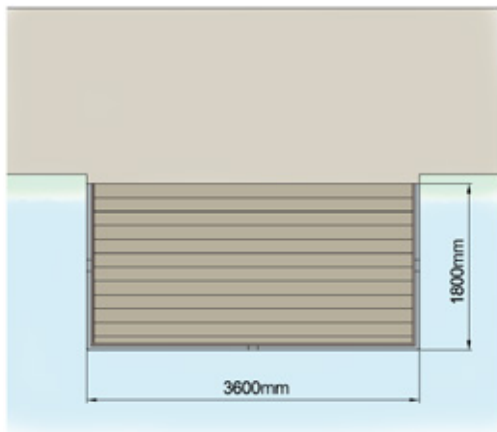

Over-water platform 3600mm x 1800mm

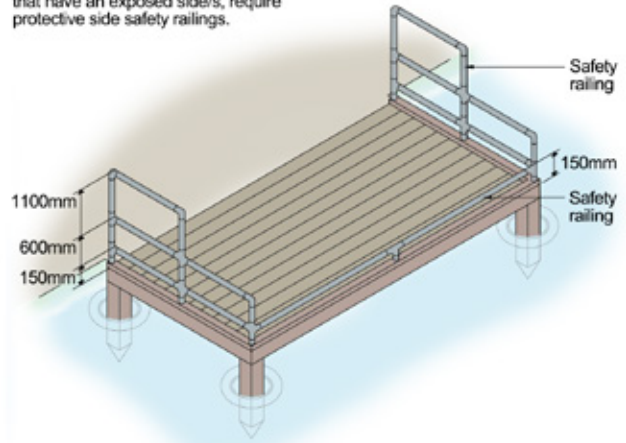

Diagram B - Fishing Platform 3600mm x 1800mm

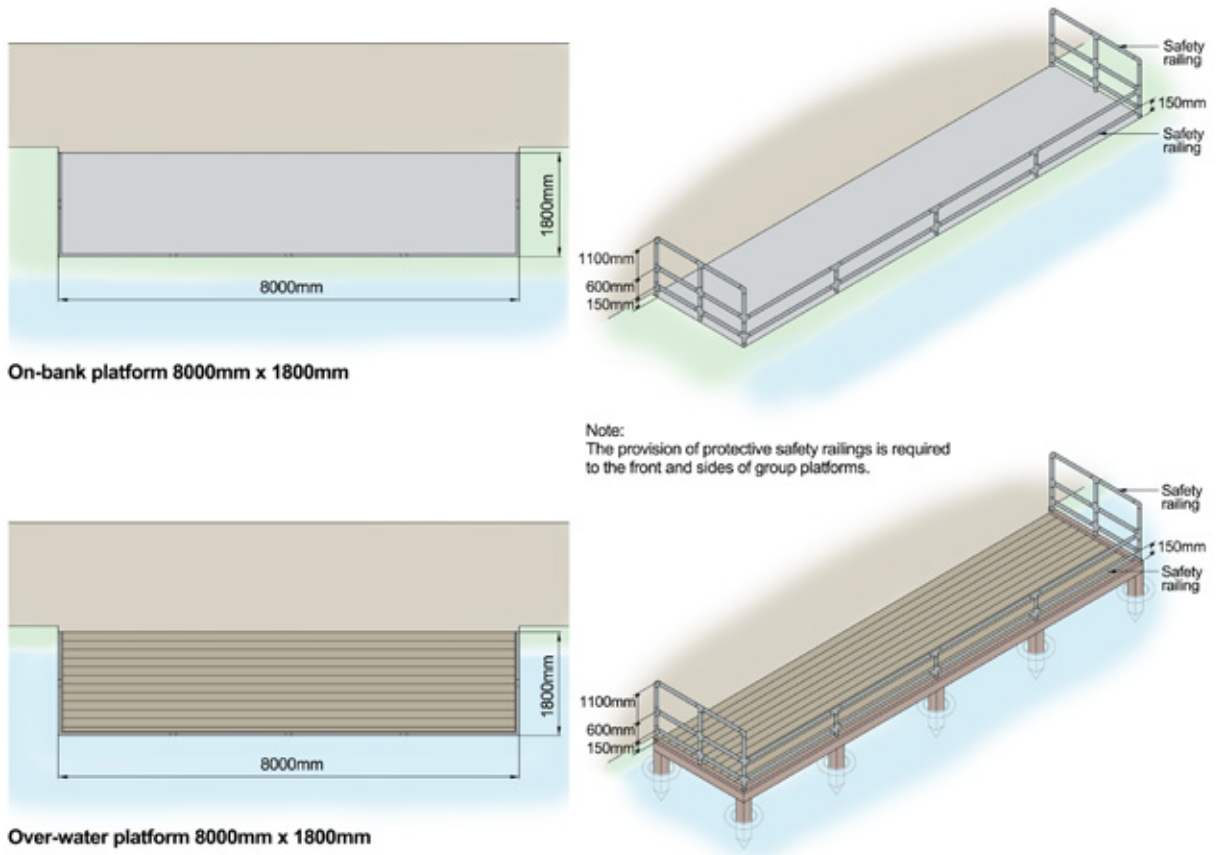

Diagram C - Fishing Platform 8000mm x 1800mm

Figure 27 - Design Options for Accessible Fishing Stands and Platforms



Fishing stand with concrete slip resistant surface and adjacent bench rest seat at Moyola Nature Reserve



Lough Erne Queen Elizabeth fishing stands
(Image courtesy of Department of Agriculture,
Environment and Rural Affairs)



Fishing stands on River Lagan (Image courtesy of Department
of Agriculture, Environment and Rural Affairs)



White Lough over-water fishing platform with
accessible approach route (Image courtesy of
Department of Agriculture,
Environment and Rural Affairs)

4.5.2.1 Design factors

Recommended Standards

- Incorporate the existing embankment where possible at rivers, lakes and pools. This negates the need for side safety guardrails. **Note:** low-level side guardrails/upstands could present a potential trip hazard to people who are blind or partially sighted where the stand or platform is flush with the adjacent ground, so should be avoided.
- Different support structures will be required for different bases and underwater conditions (for example, a lake or a riverbed). Structural engineering advice should be sought to ensure adequate stability and safety and loadbearing capacity of frame supports, secure fixing to embankments etc e.g. from groups of anglers, users of electric mobility scooters or powered wheelchairs.



Guidance Signpost

- ▶ British Disabled Angling Association. BDAA National standard of “accessible for all” platforms.
https://bdaa.co.uk/pdfguide/bdaa_brochure.pdf
https://bdaa.co.uk/pdfguide/bdaa_guide.pdf
- ▶ Short Guide to Public Angling Estate Fisheries Accessible to Anglers with Disabilities. Department of Agriculture, Environment and Rural Affairs Northern Ireland.

4.5.3 Proximity to water level

Overview

On-bank fishing stands and over-water fishing platforms should be as close as possible to the water level taking safe seasonal tidal conditions/water level changes into account e.g. they should not be located on a flood plain where erosion or contamination may occur and excessive maintenance will be required, or on a riverbank prone to subsistence.

Recommended Standards

- Maximum height of above the water should be 600mm (in the range 300mm-600mm).
- On-bank fishing stands should be maximum 300mm horizontally from the edge to the water line to avoid an angler having to lean forward excessively when landing their catch.

4.5.4 Rails to on-bank fishing stands and over-water platforms

Overview

Considering a range of accessible fishing locations will offer a variety of fishing experience to disabled anglers e.g. by locating stands or platforms to avail of variations in water depth, vegetation and associated light/shade, proximity to the bank or shore etc. Guardrails and handrails are required for safety protection where fishing stands or platforms are positioned at a higher level than the adjacent land or water and to assist users to retain balance while entering or exiting the stand or platform e.g. to assist anglers who are blind or partially sighted.

Rails should be provided to offer fishing opportunities to disabled anglers whether they are wheelchair users or standing persons.

Recommended Standards

- The hazard of exposed embankments nearby to the water edge can be reduced by providing appropriate guardrails or fencing.
- On stands and platforms, provide side safety railings 1100mm above ground level and extending to the adjacent external route if there is an exposed drop or water on one or both sides. An additional 600mm high rail will assist children and wheelchair users e.g. to rise from seated level and to retain balance. **Note:** regulations for guardrail protection may vary depending on specific settings.
- See Section 1.6 of this guide: Handrails.

- Provide a contrasting 150-200mm high upstand rail at the front of stands and platforms to prevent wheelchairs, scooters or all-terrain vehicles from going over the edge (or deck/surface that extends minimum 300mm beyond the inside edge of railings). **Note:** the rail can also serve as a tapping rail to assist people who are blind or partially sighted.
- Provide an additional support rail at the front of 8000mm wide over-water platforms (600mm high).
- Where feasible, providing angling rails at a variety of heights can offer fishing opportunities to assist disabled anglers with a range of needs e.g. a 500mm high angling rail enables a an angler to fish to the sides of platforms as well as from the front.
- Optional breaks in railings should be 200-250mm wide.
- Provide clear space at each lowered angling rail minimum 900mm by 1400mm (1500m by 1500mm preferred to allow clear wheelchair turning).

4.5.5 Net dipping locations

Most fisheries have a disease prevention system to clean nets prior to fishing. For these to be accessible and safe consider the following:

- Maximum height 650mm above ground level.
- Firm, level and well drained ground surface adjacent.
- Container can be set on level ground and not tip over.
- Clear information about the contents of the dip, in case of allergic reaction.



Guidance Signpost

- ▶ http://www.outdoorrecreationni.com/wp-content/uploads/2012/04/Community-Toolkit-to-Success-Writing-Successful-Funding-Applications_ORNI-2012.pdf
- ▶ British Disabled Angling Association. BDAA National standard of “accessible for all” platforms.
https://bdaa.co.uk/pdfguide/bdaa_brochure.pdf
https://bdaa.co.uk/pdfguide/bdaa_guide.pdf
- ▶ ADA Checklist for Existing Facilities: Fishing Piers and Platforms. 2016. <https://adachecklist.org/doc/rec/fishing/fishing.pdf>

4.5.6 Sea fishing from the shore



Guidance Signpost

- ▶ British Disabled Angling Association. BDAA National standard of “accessible for all” platforms.
- ▶ ADA Checklist for Existing Facilities: Fishing Piers and Platforms. 2016. <https://adachecklist.org/doc/rec/fishing/fishing.pdf>

4.6 Access to Beaches

Overview

Disabled people have the same rights to enjoy beach activities as non-disabled people, however, beaches can present challenges e.g. wheelchair users will find sand and long grass surfaces difficult, and people with sensory or neurological conditions may become easily disorientated in an open expanse. Location, ground surface, natural topography and environmental features such as dunes and rocks should not be used as a means of justifying lack of suitable access provision at beaches. Permanent design adaptations and temporary physical features can overcome many challenges.

Recommended Standards

- Provide accessible parking close by. See Section 1.1 of this guide: Parking and Setting-down.
- Provide accessible toilets, a Changing Places toilet and accessible changing and showering facilities close by. See Section 2.5 of this guide: Accessible Toilets, Changing and Showering.
- Where access onto a beach requires ramps and steps, they should be designed in accordance Sections 1.4 - 1.6 of this guide.
- Existing steep slopes may require an alternate, more accessible route. This should be clearly marked on maps and on signs using symbols.
- Provide rest seating that provides more support than standard beach deck chairs. See Section 2.2.1 of this guide: Resting places.
- At least one or 5%, whichever is the greatest, of beach huts should be accessible to wheelchair users and approachable using an accessible external route.
- Provide clear beach information display boards and maps. See Section 3 of this guide: Wayfinding, Signs and Information.
- Provide areas to shelter from the sun and wind.

- Provide accessible beach equipment. See Section 4.6.2 of this guide: Inclusive beach equipment.
- Concessions should be accessible e.g. refreshment kiosks and vending machines.

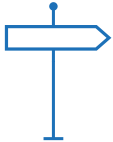

Guidance Signpost

- ▶ Mae Murray Foundation:
<http://www.maemurrayfoundation.org/projects/inclusive-beaches/>

In Northern Ireland, the Mae Murray Foundation is working on the development of inclusive beaches, to include technical issues and the management of a truly inclusive beach environment.

4.6.1 Outdoor Swimming Pools

Recommended Standards

Where an outdoor swimming pool is provided, the following measures will improve access for disabled swimmers:

- Means of access into and out of the pool e.g. level pool deck, ramp and easy steps, submersible lifting platform and poolside chairs.
- Warm water temperature.
- Accessible toilet, changing and shower facilities and a Changing Places toilet in close proximity to poolside. See Section 2.5 of this guide: Accessible Toilets, Changing and Showering.
- Secure wheelchair storage space close to poolside.
- Contrasting pool edges.
- Slip resistant surfaces at poolside.
- Underwater handrails built into the depth of the pool wall.
- Rest seats at poolside.
- Comfort mats.
- Where swimming jetties or pontoons are necessary e.g. for bathing or triathlon activities, provide access for swimming and diving. See Section 4.2 of this guide: Jetties and Pontoons.

4.6.2 Inclusive beach equipment

Overview

Beach environments can present challenges for some disabled people e.g. access across loose and uneven surfaces, and access to water activity. The introduction of inclusive beach equipment can make this easier.

4.6.2.1 Mobimats, access-mats and portable/removable mats



Deschamps Mobimat

A permanent walkway such as a beach boardwalk can provide access up to a point; however, movement across the sand to reach the water's edge can be impossible for some people without assistance or aids.

Aids such as portable mats can be used for this purpose. **Note:** an area minimum 900mm by 1400mm is required adjacent to the mat walkway e.g. when socialising with a group of friends. Access-mats and Mobimats are portable and roll-out to form a route within a variety of settings, including beaches. See: <https://www.accessrec.com/beach-access-mat>

4.6.2.2 Beach buggies and adapted wheelchairs



Benone Strand inclusive beach floating Mobi-Chair

A range of beach buggies and adapted wheelchairs which have large wheels that can easily negotiate sand to make accessing the beach and the water easier are available. Some combined floating chairs are also available for use in the water to enable disabled people to participate in water activities. Examples include:



Floating chair at Benone Strand Inclusive Beach Launch



Floating Mobi-Chair at Benone Strand Inclusive Beach Launch

Floating chairs are available for use on the sand and in the water using the side buoyancy aids. They have a harness (removed before entering the water), waterproof back pocket and seat adjustment. The handle/strap allows the chair to be pulled easily by an assistant. Available in child and adult sizes.



Debug wheelchair (Image courtesy of Mae Murray Foundation)

Debug wheelchairs are made of stainless steel and easily negotiate a range of terrain such as sand, gravel and grass but are best suited to compacted sand and flat ground. The elevated leg rest provides additional comfort and support.



Hippocampe Beach Buggy - Benone Strand Inclusive Beach Launch

The Hippocampe Beach Buggy is suitable for use on soft sand and can be used on the beach and within sand dunes where the ground is uneven or hilly. It offers supportive arm, head and backrests as well as mesh foot and leg support.



Guidance Signpost

- ▶ Mae Murray Foundation: <http://www.maemurrayfoundation.org/projects/inclusive-beaches>

4.6.2.3 Surfboards



Cerebra Sit-down Surfboard - Benone Strand Inclusive Beach Launch

The Cerebra Sit-down Surfboard was created by Surfability UK and the Cerebra Innovation Centre. It was designed for children with brain conditions and for children with reduced mobility. The tandem design includes a supportive seat for the child and space for experienced surfer to steer. Surfboards suitable for people who are blind or partially sighted are currently being developed.



Guidance Signpost

- ▶ Cerebra:
<https://www.cerebra.org.uk/cerebra-innovation-centre-portfolio/surfboard>
<https://youtu.be/4WvQboqwh74>

4.6.2.4 Beach walkers

Overview

Beach walkers offer adults or children with mobility difficulties, and older people, to move across the sand more easily.



Beach Walking Aids/Crutches

Beach walking aids/crutches have large rubber feet and armrest support to make moving on the sand easier.



Beach Job® Walker

Large wheels and easy grip handles at two heights make the Beach Job® Walker a useful mobility aid when moving on the sand. It also provides an integrated seat, making it a combined chair and walker in one.



Debug Walker and Debug Baby Jogger Pushchair (Images courtesy of Mae Murray Foundation)

Debug Walkers and Pushchairs have large wheels to easily negotiate the sand, to assist older people or walkers with mobility difficulties and parents pushing children.

4.6.3 Beach boardwalks and accessible external routes

Recommended Standards

- Width should be in accordance with Section 1.2 of this guide: Accessible External Routes - Paths, Trails and Greenways. 2000mm permits clear passage in both directions without the necessity for passing places. **Note:** beach sites with expected heavy footfall during busy seasons will require boardwalks with greater width to ensure the safety of all users (effectively greenway standard).
- Widths reduced to 1500mm or 1200mm are not considered acceptable where two-way travel is anticipated, and only for short distances where narrowing is necessary to avoid localised obstacles.
- Unsuitable surface materials include cobbles, moss, loose gravel, uncompacted grass and dust binding.
- Suitable surfaces which offer firm, stable accessible boardwalks and external routes in beach settings could include pressure-treated timber, recycled composite decking, modified non-toxic timber, concrete or bitmac.
- Boards should be laid perpendicular to the direction of travel and any joints/gaps in ground surfaces should be maximum 5mm.
- Any surface should incorporate a slip resistant finish.
- Provide definition to assist people who are blind or partially sighted e.g. a verge comprising colour and texture difference, or a 150mm high tapping rail.
- See Section 1.2.5 of this guide: External route ground surfaces.



Guidance Signpost

- ▶ Kebony: <https://kebony.com/en/blog/boardwalk-decking-construction-and-design-ideas/>
- ▶ Mae Murray Foundation: <https://maemurrayfoundation.org>

Section

5

Outdoor Wheelchairs, Adapted Cycles and Inclusive All-terrain Vehicles

- 5.1 Outdoor Wheelchairs
- 5.2 Adapted Cycles
- 5.3 Inclusive All-terrain Vehicles



Tomcat Trike (Image courtesy of Causeway Coast and Glens District Council)

Introduction

A range of outdoor wheelchairs, adapted cycles and inclusive all-terrain vehicles are now available to enable disabled people to access and explore outdoor places, many of which would have previously been inaccessible to them. This section provides a summary of the most popular outdoor wheelchairs, adapted cycles and inclusive all-terrain vehicles available. When purchasing any outdoor wheelchairs, adapted cycles and inclusive all-terrain vehicles, ensure to test/consult with a range of disabled people.

5.1 Outdoor Wheelchairs

Overview

The use of outdoor wheelchairs enables wheelchair users and people with mobility difficulties to access a wide range of outdoor settings and terrain, ranging from easy terrain routes through parks and forests to more challenging wild and open countryside terrain. Some examples of the most innovative and /or popular outdoor wheelchairs are provided below.

- **Mountain Trike**



(Image courtesy of Mountain Trike)



Ramble through woodland
(Image courtesy of Mountain Trike)

The Mountain Trike features a rear stability wheel and chunky off-road tyres which enables users to access a range of more difficult terrain. It is self-propelled using two hand levers on a ratchet system so requires reasonable to good upper body strength to operate effectively.

- **Mountain Trike Push**



Mountain Trike Push off-road attendant chair
(Image courtesy of Mountain Trike)

The Mountain Trike Push is similar to the Mountain Trike but has been designed to be pushed by a buddy/assistant wheelchair. Unlike the self-propelled Mountain Trike, it has an adjustable push handle located behind the seat with steering and braking controlled by the user's buddy/assistant.

- **Mountain Trike eTrike**



eTrike electric assist all-terrain wheelchair
(Image courtesy of Mountain Trike)

This is an electric assisted version of the Mountain Trike, which allows users to travel further, faster and negotiate more challenging terrain, as well as offering the ability to combine manual power with electric assist when desired.

- **Wizzybug**



(Image courtesy of Designability and Photographer Bellabambini)



(Image courtesy of Designability)

Wizzybug enables disabled children up to the age of five to enjoy outdoor places such as parks, gardens and playgrounds. Wizzybug is a powered chair operated using a simple joystick control and is designed for children with physical disabilities such as cerebral palsy, spinal muscular atrophy, spina bifida or muscular dystrophy. **Note:** Designability is currently working with the Mae Murray Foundation to make the Wizzybug available to hire in Northern Ireland. For more information visit: <http://www.maemurrayfoundation.org/>

- **Trekinetic**



(Image courtesy of John Preston Healthcare)

Trekinetic is a new style of wheelchair which can be adapted for off-road as well as everyday use. The wheel at the rear aids stability whilst the shock absorber system gives users a more comfortable ride. A powered option is also available called Trekinetic GTE.

- **Front Wheel Attachments**

A range of front wheel attachments are also available which when used with a standard wheelchair enables the wheelchair user to access some outdoor places. Examples include:

Freewheel: The Freewheel is designed to fit securely onto most manual, rigid-frame wheelchairs giving a secure fit and excellent handling in snow or over rough terrain.

Triride Special L14: The Triride Special L14 wheelchair power attachment has a powerful motor and offers smooth off roading capability. It attaches to a manual wheelchair, has a 14 inch front wheel, a 1500W motor and a range of 30+ miles.

Firefly: The Firefly is a battery powered attachment that can be fitted onto most standard wheelchair frames. It assists the user through battery power e.g. on difficult inclines or over long distances.

Dragonfly: The Dragonfly is similar to the Firefly but it offers a hand cycle option whereby the faster the user propels using the hand cycle system, the more power is supplied by the battery pack. This hand cycle type cardiovascular workout may be a more attractive option for some people.



(Dragon Fly: Image courtesy of John Preston Healthcare)

5.2 Adapted Cycles

Overview

A wide variety of adapted cycles are now available which enable disabled people to get out and enjoy the outdoors with their friends and family. Information on some of the most popular models is provided below.

- **Recreational Hand Cycle**



(Image courtesy of John Preston Healthcare)

These cycles are a hybrid between a wheelchair and a bicycle, enabling those with lower limb, mobility, or balance issues to propel the cycle using their hands/upper body. These are most suitable in an enclosed area such as a park or cycle path environment.

- **Tandem Cycle**



(Image courtesy of John Preston Healthcare)

These are 2-seated cycles aimed particularly to benefit people who are blind or partially sighted. A sighted 'pilot' sits on the front seat whilst the person who is blind or partially sighted occupies the rear seat. The tandems could also be beneficial for people who do not have the skills/confidence to ride a standard bike alone.

- **Tomcat Trike**



(Image courtesy of Causeway Coast and Glens District Council)

A 3-wheeled cycle suitable for children and teenagers (4-16yrs) who have mobility or balance difficulties. They are best suited to an indoor, path or cycle path environment. Seating is a standard saddle with small side seat posts to aid balance. Braking can be controlled using the rear carer control attachment.

- **Tomcat Bullet Trike**



(Image courtesy of TomcatUK)

This type of cycle is suitable for adults and teenagers. It features a lower seating position, comfort seating and a harness. A split frame model is available for easier transporting/storage and a swivel seat option is available for ease of transfer on/off the trike.

- **Workman Side by Side Tandem**



(Image courtesy of John Preston Healthcare)

These tandems, sometimes called ‘Social Tandems’, are suitable for a range of users. The seating position means that users need to have a reasonable amount of mobility and balance. Both users can pedal at the same time, with one controlling the steering.

- **Van Raam Velo Plus Wheelchair Transporter Bike**



(Image courtesy of TomcatUK)

This cycle has been developed, to enable those with high levels of impairment to ride on the front platform in their wheelchair whilst a competent cyclist operates the cycle.

5.3 Inclusive All-terrain Vehicles

Overview

The availability of an increasing range of inclusive all-terrain vehicles gives disabled people a fantastic opportunity to access a range of outdoor places which previously would have been totally inaccessible to them. This ranges from easy terrain routes through parks and forests, mountain bike trails as well as more challenging wild and open countryside terrain. Some examples of the most popular inclusive all-terrain vehicles are provided below.

- **Quadrix Watts**



This is an electric battery powered 4-wheeled vehicle with bucket seating, harness and roll cage and thumb operated throttle. Its agility and light steering system means it is well suited for use on Green/Blue level mountain bike trails. On full charge, vehicles can run for several hours giving disabled people an opportunity to explore outdoor environments for several hours.

- **Quadrix Axess Touch**



This is a joystick operated version of the Quadrix, particularly suitable for people with high levels of impairment. There is a reduction in speed and agility compared to a standard Quadrix, however the vehicle is still able to operate on a range of surfaces including loose stone paths, grass and some green/blue level mountain bike trails.

- **Terrainhopper**



This is an electric battery powered 4-wheeled vehicle with an automatic braking system, comfortable seating, finger throttle and chunky off-road tyres. It enables disabled people to enjoy a leisurely ride on walking/mixed use trails and can handle reasonably steep, off-camber terrain with ease. On full charge, vehicles can run for several hours. A joystick operated version is also available to facilitate use by people with higher levels of impairment.

- **TGA Vita X Scooter**



(Image courtesy of John Preston Healthcare)

A more robust mobility scooter suitable for use on off-road rough terrain environments. It does not come with any foot or seating straps, so is only suitable for people with a reasonable level of mobility and balance.

- **Tramper Scooter**



(Image courtesy of Beamer Ltd)

A electric battery powered vehicle with a rugged chassis, all-round suspension and larger than normal rear wheels giving the user the ability to drive over rough ground, mud and snow. They can climb inclines up to 25% and their light, accurate and precise steering gives a feeling of safety and security.

- **Zoom**



(Image courtesy of John Preston Healthcare)

An electric battery powered vehicle with a permanent symmetrical 4-wheel drive designed for use on rough terrain. During use all four wheels stay in contact with the ground regardless of the type of surface ensuring good performance under all conditions.

- **Boma 7**



(Image courtesy of Equal Adventure)

The electric battery operated Boma features a steel tubed chassis, all-round suspension, powerful drive axle and low centre of gravity making it capable and stable off-road. While the steering is light and responsive, it also gives users a sense of being involved in the ride. The throttle can be fitted on either the left or right side (or both).

- **Breeze Scooter**



(Image courtesy of TGA mobility)

This scooter's the all-round, fully active and adjustable suspension provides comfort and complete control over rough terrain. It has a powerful motor, large wheels and pneumatic tyres which provide maximum ground clearance and can accommodate users up to 39stone (248kg).

- **Ziesel**



(Image courtesy of Mattro GMBH)

The Ziesel features a powerful electrical drive, intuitive joystick control and cross-country mobility, rubber track belts, LED headlights, indicators, stop lights and rearview mirrors, an has an easy to use operator panel and armrest display.

- **Joëlette**



(Image courtesy of Joelette & People Experience, Scotland).

The Joëlette is an all-terrain one-wheeled chair that enables any person with reduced mobility or disability, children or adult, to get involved in hiking excursions or running activities with the help of at least two guides. The rear guide handles the balance and the front guide controls the traction and gives the direction. Designed for both family outings and more intense sports and recreation, the Joëlette enables access to the roughest terrains that would be inaccessible using a standard wheelchair. When folded, the Joëlette fits easily in a car boot.

Section

6

Inclusive Play - Accessible Play Parks and Play Equipment

- 6.1 Accessible Play Parks
- 6.2 Accessible Play Equipment
- 6.3 Play Park Surfaces
- 6.4 Slopes and Planting in Play Parks
- 6.5 Associated Play Park Facilities



Inclusive Play Wildlife Wheelspin (Image courtesy of Jupiter Play & Leisure)

Overview

This section of the document has been produced to provide technical guidance on the successful design of accessible play parks and associated facilities, including advice on the provision of accessible play equipment. However it should be noted that the guidance relates to only some elements of the developing concept of inclusive play. Signposts to further information on different models of inclusive play and inclusive play guidelines which Disability Sport NI is aware of is provided below:



Guidance Signpost

- ▶ ADAPT to Play - The ADAPT to Play framework, which incorporates an 'inclusive playpark design toolkit' is currently being developed (September 2021) by the lead organisation for the development and promotion of play in Northern Ireland, Playboard NI, in partnership with the Mae Murray Foundation.

Further information - <https://www.playboard.org> or <https://www.maemurrayfoundation.org>

- ▶ PiPA (Plan Inclusive Play Areas) - PiPA is an assessment and accreditation toolkit for inclusive play parks created by the play equipment company Inclusive Play, in partnership with KIDS the disabled children's charity and Occupational Therapists Constance Hurley and Amy Wagenfeld. The scheme was included in the UK Government's Accessible Britain Challenge and was hailed as a best practice document for playground design by the UK's Design Council.

Further information - <https://www.inclusiveplay.com>

- ▶ Me2 7 Principles of Inclusive Playground Design - An inclusive play programme developed in the USA by Playcore in partnership with Utah State University, Center for Persons with Disabilities.

Further information - <https://www.playcore.com/programs/me2>

- ▶ Harper's Playground - An inclusive play model and assessment tool developed in the USA by Harper's Playground.

Further information - <https://www.harpersplayground.org>

- ▶ HAGS Guide to Designing an Inclusive Playground - A inclusive play design guide created by a Swedish based company HAGS in collaboration with playground and child development experts.

Further information - <https://www.hags.com/en-us/designing-inclusive-playgrounds>

6.1 Accessible Play Parks

Although the provision of accessible play parks is only one element of inclusive play, where provided they should be designed to be accessible to disabled children. This can be achieved through the implementation of the following accessibility standards:

Recommended Standards

- External routes around play parks should be 2000mm wide (minimum 1200mm wide internally on one-way routes around play parks).
- An entrance gate with a minimum width of 1200mm. Avoid steps, ramps and drainage grids at the play park entrance point.
- Accessible routes from the point of arrival at the play park, throughout the play park and leading to huts, shelters and amenities should be provided.
- Huts and shelters which encourage creeping, hiding, meeting, conversation and role play should also be designed to be accessible.
- Accessible ground surfaces should be provided alongside huts and shelters to give disabled children the option to transfer into the hut/shelter from their wheelchair.
- The provision of rest and lean opportunities for children with limited grasping ability e.g. support guardrails for children using crutches and play equipment which allows leaning.
- Handrails at an accessible height for children on ramps, play trails or play bridges.
- Contrast or tactile information to any potential danger or fall area around play pieces to assist children who are blind or partially sighted.
- Sensitive and creative use of colour to assist people with sensory disabilities e.g. use of pastel, earth and monochrome colours.
- Braille and finger spelling displays to encourage sign language learning (BSL and ISL in Northern Ireland).
- The provision of a protected quiet space away from busier activities for children who wish to retreat should they become anxious or overwhelmed.
- Accessible signage throughout the playpark - See Section 3 of this guide: Wayfinding, Signs and Information.

6.2 Accessible Play Equipment

Although play equipment is only one element of the concept of inclusive play, it is important that where equipment is provided it is accessible to disabled children. As few/if any individual pieces of equipment will meet the particular needs of every disabled child, it is recommended that a varied and balance range of equipment is provided.

To assist with the selection of equipment, information on the accessibility benefits of a range of play equipment is provided below:

- Multi - play Units- see section 6.2.1
- Rockers, Swingers and Seesaws - see section 6.2.2
- Flush Trampolines - see section 6.2.3
- Flush Roundabouts - see section 6.2.4
- Inclusive Swings - see section 6.2.5
- Inclusive Slides - see section 6.2.6
- Sensory Play Equipment - see section 6.2.7

Particular consideration should also be given to the provision of play equipment which can be used by disabled children who cannot transfer from their wheelchair.

6.2.1 Multi-play Units

Inclusive play parks are enhanced through the use of multi-play units which offer:

- Ramped access to all or some play elements on the one piece
- Low-level and/or duplicate play opportunities at different levels e.g. climbing nets at low, medium and high level
- Sensory play panels
- Low-level transfer platforms
- Listening and reading elements

The inclusion of multi-play units also ensures that play for older disabled children is not limited only to the use of toddler play equipment, which naturally tends to be at low levels. Three examples of inclusive multi-play units are provided below:



Loughshore play park with themed multi-play unit, swings and flush roundabout (Image courtesy of Garden Escapes NI)



Accessible multi-play unit with ramped access, People's Park Ballymena (Image courtesy of Garden Escapes NI)



Lilian Bland play park Glengormley showing nest swing for sitting/lying and shared-use, ramp to multi-play airplane unit and wet pour play surfaces (Image courtesy of Garden Escapes NI)

6.2.2 Rockers, Springers and Seesaws

An inclusive play rocker/seesaw enables transfer, sitting or lying options for a number of children. High back seats and secure armrests offer support and act as grab handles. Easy grip handles are also provided to assist children using the central nest seat.



Inclusive RoxAll seesaw for transfer and sitting/lying (Images courtesy of Gametime®)

Inclusive motion rockers allow children to play together, whether they use a mobility aid or wheelchair, require a seat to rest or transfer to, or rails to lean on or hold onto. Level or sloped entry provides easy access. They are also spacious enough for multiple users and companions should additional support be required.



Rock n Raft in action (Image courtesy of Gametime®)



Mulcahy Sensory Play Park Clonmel showing accessible Gametime® Rock n Raft in natural colours (Image courtesy of Garden Escapes NI)



An inclusive 8 person play springer which enables transfer, sitting or lying options and has easy grip handles and space for a companion should additional support be required. (Image courtesy of Garden Escapes NI)



Inclusive ground level seesaw, Brooke Park Derry-Londonderry (Image courtesy of Derry City and Strabane District Council)

6.2.3 Flush Trampolines

Flush ground level trampolines enable disabled children to access a trampoline without the need to climb or transfer. Its large size also enables several children and/or accompanying adults to play together.



Inclusive flush trampoline (Image courtesy of Jupiter Play & Leisure)



Inclusive flush trampoline (Image courtesy of Garden Escapes NI)

6.2.4 Flush Roundabouts

- A roundabout flush with the ground enables children using mobility aids and wheelchairs to access it easily from the open side, whilst also allowing groups of children of all abilities to play together. It should include a rest seat and easy grip rails to assist children who require additional support.



Inclusive Play Wheelspin flush roundabout (Image courtesy of Jupiter Play & Leisure)



Inclusive flush roundabout, Brooke Park Derry-Londonderry (Image courtesy of Derry City and Strabane District Council)

6.2.5 Inclusive Swings

There are three main types of accessible swings available, a basket/nest swing, cradle swing and roll on swing. A description of the benefits of each swing is provided below. Where feasible, the provision of all three types of swings in the same play park will provide the maximum level of choice for disabled children with a range of different needs.

Nest or Basket swings provide social and group play opportunities whilst sitting or lying. They are large enough to allow a disabled child to be accompanied by siblings or a parent should additional support be required. Nest or basket swings should be 150 - 250 mm above ground level



Nest swing, Drumahoe Play Park (Image courtesy of Derry City and Strabane District Council)

Cradle swings provide supportive swinging play alongside standard swing options, so that children of all abilities can play in close proximity. The high back and secure strappings assist children who need additional support.



Zero-G cradle swing (Image courtesy of Gametime®)

Roll on swings enable wheelchair users to access a swing without transferring.



Wheelchair accessible swing, Brooke Park Derry-Londonderry
(Image courtesy of Derry City and Strabane District Council)

6.2.6 Inclusive Slides

As many disabled children will be unable to use standard traditional standalone slides with steps the inclusion of mound/embankment slides is recommended. This will assist children who cannot use steps but find climbing and crawling manageable.

The slide should be wide enough to allow children to be accompanied if preferred.

Where possible slides accessed by ramps and/or transfer platforms should be used instead of slides accessed by steps.



Mulcahy Sensory Play Park, Clonmel showing wide mound slide, Gametime® sensory wave arch and discovery cave (Image courtesy of Garden Escapes NI)



Harper Gateway



Double width slide

6.2.7 Sensory Play Equipment

The provision of a range of sensory play equipment reachable from a crawling, seated or standing position and offering visual interest through colour is recommended. Where possible this should include:

- Musical equipment e.g. musical chimes, sound gongs, bells and pipes.
- Passive sound equipment e.g. tube phones or parabolic sound reflector.
- Equipment that facilitates outdoor art opportunities e.g. chalkboards.
- Sensory play panels which offer tactile play opportunities.
- Interactive technology play pieces to enhance the sensory, movement and play experience e.g. Yalp Sona Arch or iPlay.



Colourful vertical rainbow chimes on a firm, wet pour play surface (Image courtesy of Garden Escapes NI)



Cathedral Gardens play park Belfast showing a musical xylophone with other sensory equipment in the background e.g. tactile Rain Wheel and, low level climbing options and play surfaces (Image courtesy of Garden Escapes NI)



Inclusive Play tactile Orb (Image courtesy of Jupiter Play & Leisure)

This colourful orb provides visual, tactile and sensory interest for all children. It rocks, makes a sound, can be touched, climbed on or sat on.



Sensory play panel (Image courtesy of Garden Escapes NI)



Yalp Sona Arch - making interactive play accessible for all children
(Image courtesy of Jupiter Play & Leisure)

6.3 Play Park Surfaces

Overview

Inclusive play parks should have ground surfaces that are safe and accessible i.e. impact absorbing and easy to walk and wheel on.

Playground surfacing broadly falls into two categories:

- Unitary materials: wet pour (poured-in-place rubber), synthetic turf, bonded rubber and rubber tiles.
- Loose-fill surfaces: Engineered Wood Fibre, loose-fill rubber and sand or pea gravel (these must be used with caution). Note: EWF is natural wood which is engineered to "knit" together to form an impact absorbing surface.

The use of some carefully designed natural surfaces such as grass, where normally natural surfaces may be uncommon, can add play value and sensory experience e.g. in urban parks. Introducing sand in raised sand beds is an option to avoid a loose-fill uneven surface underfoot. When using grass it should be well compacted and level, well drained and maintained, and only used where impact absorption is not required e.g. grass borders or meadow grass alongside routes to add sensory appeal.

Unsuitable play park surfaces include unbonded loose materials such as pea gravel, bark mulch, woodchips, loose rubber shreds and non-compacted long grass.

Recommended Standards

- Play pieces should be located to avoid areas where puddling, mud or standing water is likely to occur as this can restrict access (or implement drainage measures to overcome this).
- Providing a good balance between the use of carefully designed bonded and natural ground surface areas is useful. A mix of hard and soft surfaces in close proximity can encourage family and social interaction and integrate the benefits of both in terms of play value, safety and visual impact. However, routes leading to and at inclusive play equipment or tactile/sensory elements should not comprise loose surface materials.
- The use of natural ground surfaces as far as possible is encouraged, but with safety and protection from impact considered as the priority i.e. use of impact absorbing surfaces.
- Boardwalks or bridges should be used to cross sand or loose material areas, which may otherwise be used as play elements in parks. See Section 1.2.11 of this guide: Boardwalks and bridges.
 - See Section 1.2.5 of this guide: External route ground surfaces.



Mulcahy sensory play park Clonmel showing defined looped route, offset sensory equipment on firm surface, mound slide and cradle swing chairs (Image courtesy of Garden Escapes NI)

6.4 Slopes and Planting in Play Parks

- Where possible, the design of play parks should utilise existing natural features and landscape to promote multi-sensory play experiences e.g. tactile logs and trees, sound from trees and water, light and shade, natural shelter, smell from natural vegetation and natural hiding/quiet/social places.
- Natural mounds, gentle slopes and steeper hill terrain can offer challenge and enjoyment in play and areas to sit and converse. If suitably graded and careful attention is paid to ground surface finish and quality, the landscape can provide natural ramped access within play parks e.g. use the natural landscape to address changes in level onto platforms, bridges and towers where possible, to reduce the need for steps or ramps, use an earth mound for an embankment slide.
- External routes leading to and around play parks should not be steeper than 1 in 21 gradient. Slopes steeper than 1 in 21 are ramps and should be designed in accordance with ramped standards. See Section 1.4 of this guide: Sloped Gradients and External Ramps on External Routes and Section 1.6 of this guide: Handrails.
- Integrating planting and trees on curved, looped and flowing external routes is a means of achieving natural aesthetic whilst also providing sensory play experience within close proximity to formal play equipment.
- Provide planting reachable from standing or seated positions.
See Figure 12 of this guide: Planting Bank and Figure 13 of this guide: Raised Beds (sand, water and planting).



Play park mounds (Image courtesy of Playcore)

Low-level and sloped play mounds provide opportunities for climbing, crawling and challenge e.g. for children who find steps difficult. They allow for the introduction of support rails and bars to assist climbing or leaning if required.



Raised pedestal sand table for children
(Image courtesy of Hand Made Places)

6.5 Associated Play Park Facilities

It is important that play parks also meet the needs of accompanying adults, who may often be older people or grandparents.

Recommended Standards

- The provision of accessible parking.
- Where toilet facilities are provided they should include the provision of accessible toilets.
- The approach to play parks should be easy, on firm, level ground or with as shallow a gradient as possible. In settings where natural topography can make this difficult, explore options for least restrictive access in terms of gradient and offer support in the form of handrails and level landing areas for respite.
- Resting places and seating should be provided for respite or quiet and to enable social interaction between family members or other adults - See Section 2.2: Resting Places and Seating.
- Adult supervision spots with good sightlines should be provided, whilst maintaining opportunities for independent or social play.
- Outdoor gyms and mobility equipment close to the play park can encourage all generations to be active. Where exercise equipment is provided, some apparatus should be included to accommodate the needs of older people, wheelchair users and people who are partially sighted.



Providing rest and shelter; also showing play surfaces to define play elements and routes, low slide, cradle and nest swings (Image courtesy of Gametime®)



Play park accessible storytelling area and raised planting area (Image courtesy of Garden Escapes NI)

Appendices

Appendix A The Importance of Maintenance

Appendix B Acknowledgements

Appendix A

The Importance of Maintenance

Overview

Maintenance is key in ensuring the continued accessibility of inclusive outdoor places.

Recommended Standards

- Parking along access and external routes should be discouraged.
- Vegetation along external routes, including on sensory trails, should be trimmed to maintain clear width and headroom.
- Inspect and drain waterlogged external routes to ensure quality ground surfaces and prevent potential slip hazard.
- Undertake ongoing assessment of compliance of gaps, gates and stiles e.g. repair of broken latches and hinges.
- Regularly inspect and maintain wayfinding signs, waymarkers, information display boards etc to ensure they are clearly visible.
- Ensure that external steps and ramps remain stable, usable and safe in all weathers e.g. remove debris, standing water, snow and ice.
- Handrails should be regularly inspected to ensure that they are firmly secured and that there is no splintering or cracking.
- Regular cleaning of guardrail infill panels at viewing areas.
- The ground around tactile signs, interpretation boards and maps should be regularly cleared.
- Repair or replace damage to beach boardwalks and routes and prevent vegetation encroachment.
- Clear loose pebbles and build-up of sand on beach boardwalks and routes.
- Fishing stands and platforms should be regularly inspected and maintained to ensure they do not become slippery.
- The regular resurfacing of sections of fishing stands and platforms may be required to prevent the deterioration of the surface.
- Protruding vegetation should be maintained regularly so as not to encroach onto fishing stands and platforms.



Guidance Signpost

- ▶ For guidance on the management and maintenance within the external environment see BS8300-1:2018, **Annex A** (informative), Management and Maintenance, p.59-64.

Appendix B

Acknowledgements

Disability Sport NI would like to acknowledge the following individuals for the information they provided:

Tom Bailey, Lough Erne Yacht Club

Alison Bell, Mid Ulster District Council

Russell Bowlby, The Wild Deck Company Ltd

Donna Collins and Terry Moseley, British Disabled Angling Association

Fiona Cromwell, Designability (Wizzybug)

Jayne Fishwick, Mountain Trike

Sarah Goddard, Beamer Limited

Clare Grant, John Preston Healthcare

Sarah HamiltonCardy, RSPB

Conal Heatley, Community Multisport

Karen Hoe, Changing Places/Muscular Dystrophy

Jamie Hogan, Caley Marina

Mark Holdway, Baseline Marine Products Ltd

Sandie Jackson, The Albrighton Trust

Jackie Kay, Hansa

Nelson Liddle, Joëlette & People Experience Scotland (JAPES)

Michael Lorimer, IMTAC

Alan McCurry, Inland Fisheries, Department of Agriculture, Environment and Rural Affairs

Joff McGill, Royal Yachting Association

Claire McLernon, Outdoor Recreation Northern Ireland

Laura and Tom Maclean, Ramble Tag

Anne Madden and Graham Read, Sustrans

Rebecca Martin, Tandem Design

Amy Maycroft, Joerns Healthcare

Chris Moss, The Pontoon and Dock Company Ltd

Fiona Milne, Outdoor Recreation NI

Sarah Noble, Outdoor Recreation NI

Katharina Pachler, Mattro GMBH

David Palmar, Conservation Photographer (www.photoscot.co.uk)
Dr Suresh Paul, Equal Adventure
Samuli Pahaoja, Touch Mapper
Joselyn Rankin, Portakabin®
Benedict Room, Surfability UK CIC
Rob Smith, Active Hands
Jane Stoneham, The Sensory Trust
Jim Turner, Playpower (for EZ Dock)
Helen Turton, Derry City & Strabane District Council
Dom Walbanke, TGA Mobility
Nazia White, Tomcat UK
Kyleigh Wood, Mae Murray Foundation
Jed Wragg, Centrewire



Disability Sport NI

Unit G, Curlew Pavilion
Portside Business Park
189 Airport Road West
Belfast BT3 9ED

Telephone: 028 9046 9925

Textphone: 028 9046 3494

Email: email@dsni.co.uk

www.dsni.co.uk



Funded by



Project supported by the PHA